

UNCLASSIFIED

724969

UNIVERSITY OF CALIFORNIA  
Radiation Laboratory

Contract No. W-7405-eng-48

MEDICAL AND HEALTH PHYSICS

QUARTERLY REPORT

July, August, and September, 1952

November 10, 1952

REPOSITORY Lawrence Berkeley Laboratory

COLLECTION Main Library - UCRL Reports

BOX No. NA

FOLDER NA

Berkeley, California

1174503

TABLE OF CONTENTS

I.	BIOLOGICAL STUDIES OF RADIATION EFFECTS	3
	The Physiology and Treatment of Polycythemia Studies on 260 Patients	3
	Relative Polycythemia	50
	Secondary Polycythemia	52
	A. Cardiac and Pulmonary Types	52
	B. Polycythemia of High Altitudes	54
	Case Histories	57
	Bibliography	74
II.	THE METABOLIC PROPERTIES OF VARIOUS MATERIALS	84
	TRACER STUDIES	84
	Versene Studies with Plutonium	84
	Metabolism of Radio-Fluorine in the Rat	88
	Bibliography	101
	RADIOAUTOGRAPHY	102
	Astatine	102
	RADIATION CHEMISTRY	105
	Irradiation of Acetic Acid, Formic Acid, and Glycine	105
	High Energy Helium-Ion Irradiation of Aqueous Acetic Acid Solutions	106
	Bibliography	127
III.	HEALTH PHYSICS AND CHEMISTRY	129
	Health Chemistry	129
	Health Physics	133

## I. BIOLOGICAL STUDIES OF RADIATION EFFECTS

John H. Lawrence, M.D. - in charge

Project 48A-1

### The Physiology and Treatment of Polycythemia Studies on 260 Patients

John H. Lawrence, Nathaniel I. Berlin, and Rex L. Huff

#### Introduction

In 1892 Vaquez first described a patient suffering from a complex we now call polycythemia vera<sup>120</sup>. In 1903 Osler described several similar cases<sup>80</sup>. After reading Vaquez's description of the disease and then studying the literature, one realizes that although we are now able to treat this condition satisfactorily<sup>58</sup>, there is yet much to be learned regarding its nature and physiology. Since the original observations of Vaquez and Osler, numerous articles have appeared reporting further instances of the disease and special studies of the clinical picture, including physiology, pathology, and treatment. With the exception of Videbaek<sup>121</sup>, and Stroebel, et al.<sup>106</sup>, there are no observations of large groups in which prognosis and length of life after various forms of therapy reported in the literature. For the literature prior to 1928, one may refer to the comprehensive review of polycythemia by Harrop<sup>38</sup>. The following discussion of the clinical picture, physiology, pathology, treatment, and prognosis is based on our experience with 201 patients with polycythemia vera. We shall also include our studies of secondary and relative polycythemia and their relation to polycythemia vera.

#### Clinical Picture

Polycythemia vera refers to a condition in which there is a marked and persistent elevation in the total number of red cells in the circulation and for which no etiology can be found. Pulmonary or cardiac disease or residence at a high altitude cannot be incriminated. The onset is usually insidious and the symptoms are many and varied. Some of the more common are headaches, pains, and aches in the body and extremities, loss of memory, spots before the eyes, fatigability, attacks of mental depression, dyspnea on mild exertion, tinnitus, and dizziness<sup>111</sup>. Tinney and co-workers<sup>113</sup> roentgenographically demonstrated a peptic ulcer in 7 percent of 163 polycythemia vera patients. This is similar to the 10 percent incidence of Rose<sup>114</sup> and Bassen<sup>89</sup>. The physical findings include the bluish-red color of the skin and mucuous membranes, in contrast to the deep cyanosis associated with pulmonary or cardiac disease. The liver is palpably enlarged in about 25 percent of the cases and the spleen in 66 percent<sup>115</sup>. The blood pressure is elevated in 40 percent of the patients<sup>110</sup>. The laboratory tests reveal an elevated red cell count associated with an elevated hematocrit and

---

\* Previous Quarterly Report UCRL-1922.

1174505

elevated total red cell volume<sup>4</sup>, a normal or near normal arterial oxygen saturation<sup>122</sup>, and, in most of the patients, an elevated white cell and platelet count<sup>4, 58</sup>. Thus the clinical picture is not difficult to recognize, particularly when there is a marked elevation of the red cell count and a palpably enlarged spleen, but there are borderline cases discussed below, where the diagnosis is not so clear.

### Physiology

The physiological mechanisms involved in many cases of polycythemia are well known, particularly where there is a known anoxic stimulus to red cell production such as occurs in the case of individuals living at high altitude in whom red cell counts of 7,000,000 or more are commonly observed. The studies of Hurtado and his associates in Peru<sup>48</sup>, of Talbott, et al.<sup>108</sup>, and from this laboratory<sup>62</sup> show the correlation between the degree of polycythemia and the altitude of residence. Differing from individuals with polycythemia vera, these people living at high altitudes do not have enlargement of the spleen or elevation in the white cell or platelet counts. Of interest in this connection is the work of Tinsley and co-workers<sup>117</sup>, who have shown the relationship between arterial oxygen content and the red cell production by studying reticulocyte response and radioactive iron uptake by the red cells of patients subjected to various degrees of hypoxia or superoxia.

In the case of polycythemia vera, on the contrary, there is no known anoxic stimulus. Instead of the low arterial oxygen saturation found with secondary polycythemia values are normal or near normal<sup>122</sup>. The studies of Harrop and Heath<sup>39</sup> suggest the possibility of some abnormality in gas transfer across the pulmonary alveoli, but this does not seem proved. Numerous other studies, such as those on red cell fragility<sup>73</sup>, basal metabolism<sup>7</sup>, and bone marrow<sup>70, 71, 123</sup>, have failed to shed light on its etiology. The fact that many of the patients reported in the past have developed a complicating leukemia supports the concept of the neoplastic nature of the condition, but this adds little to our basic understanding<sup>15, 36, 48, 54, 58, 69, 89, 112</sup>. Minot and Buckman<sup>73</sup> reported that in a group of 15 patients with polycythemia vera 3 developed a complicating leukemia. Their report is typical of others<sup>106, 114, 121</sup> in which approximately 20 percent of the patients with polycythemia vera developed leukemia. Some authors believe that if patients with polycythemia vera live long enough, all of them will eventually develop leukemia. In this connection it is of interest to quote from the early writings of a distinguished student of the disease. Dr. F. Parkes-Weber, of London, says: "I take it that the extremely low colour-index in the present case in 1931 and 1932 was the expression of a relative secondary anaemia, after severe haemorrhage in an erythraemic patient. In regard to the persistent high leucocyte count in this and many erythraemic cases, I would express my views as follows: I have regarded erythraemia as a syndrome caused by a primary neoplastic condition in the erythroblastic portion of bone marrow, analogous to myelosis (myeloid leukemia) in the leucoblastic portion, but non-malignant. It has, however, gradually become clear that if this view is correct that high leucocyte counts

(chiefly due to excess of the polymorphonuclear neutrophils) found in many or most cases of erythraemia (the leucocyte count is not rarely 20,000 to 30,000) must signify that the non-malignant neoplastic condition of the erythroblastic portion of the bone marrow is accompanied by a corresponding non-malignant neoplastic condition of the leucoblastic portion of the bone marrow. Such cases are, in fact, examples of what might be termed non-malignant erythro-leukaemia. The very rare supervention in such cases of true myelosis (myeloid leukaemia) appears, therefore, to signify that the non-malignant leucoblastic factor of the erythroleukaemia syndrome has taken on the malignant neoplastic character of full-blown myeloid leukaemia, whereas at first it corresponded to the (very rare) so-called polymorphonuclear neutrophil variety or stage of myeloid leukaemia. Why does the erythroblastic factor never manifest an analogous malignant transformation?"<sup>125</sup> Recently in a visit with Dr. Parkes-Weber he reemphasized the sometimes forgotten fact that polycythemia vera is nearly always characterized by hyperplasia of the leukoblastic as well as the erythroblastic elements of the bone marrow. Our studies on this aspect of the disease are presented later in this paper. Because of this relationship it is difficult to gain information on the question of whether or not the incidence of leukemia is increased in those patients treated with radiation or with drugs such as phenylhydrazine. Apparently this question cannot be answered since there are so few groups in which follow-up has been good or for a long period of time, and there are no large groups in which one form of therapy has been compared with another. It can be stated, however, that we and others have often observed patients with polycythemia vera who have had an associated leukemic blood picture prior to treatment of either condition<sup>15, 58, 127</sup>. In the group to be discussed later, this is also true. Likewise, Rosenthal and Bassen<sup>89</sup> have described a case in which active involvement of the bone marrow, both erythroblastic and leukoblastic, was found. The patient presented a clinical and hematologic picture of polycythemia and leukemia. Neither condition had received treatment previous to that given by the authors. The tendency for patients with polycythemia vera to develop either a leukemia or an anemia in the spent phase of the disease has also been discussed by them. Again, Rosenthal and Erf<sup>90</sup>, and Hirsch<sup>43</sup> have discussed the occurrence of osteosclerosis in patients having a polycythemia vera of long duration. The tendency toward high platelet counts is also emphasized by Rosenthal<sup>89</sup>, and the tendency toward complicating thrombotic phenomena is pointed out by Stover and Herrell<sup>105</sup> and others<sup>12, 13, 78</sup>.

Reznikoff and his associates<sup>84</sup> have observed in histological studies of the bone marrow that there seems to be thickening of the intimal and subintimal tissues of the arterioles, and they suggest that this may result in a hypoxia of the blood-forming tissues and thus lead to a polycythemia. Also, of interest here is the work of Schafer<sup>95</sup>. Hypertension experimentally produced in dogs by surgical interruption of all the cervical afferent depressor pathways decreased following paravertebral sympathectomy, as did the associated polycythemia. Schafer theorizes that a bone marrow anoxia or hypoxia results from vasoconstriction of the marrow arterioles, which in turn stimulates red cell formation. These investigations led him to do a sympathectomy

in a young person suffering from polycythemia vera. The operation resulted in a temporary fall in the red cell count and also in relief of the patient's symptoms. Numerous observers have reported the association of polycythemia vera and lesions of the central nervous system in the region of the midbrain, including tumors, and Cushing's disease. In the latter case, however, we have been unable to find any evidence that there has been a real and definite increase in the total red cell volume. Neurogenic polycythemia and polycythemia associated with various types of lesions in and around the pituitary and midbrain have been discussed by Haynal and Graf<sup>40</sup>. Carpenter and co-workers<sup>16</sup> review the possible role of the hypophyseal-hypothalamic system in the pathogenesis of polycythemia. Moehlig<sup>75</sup> has partially reviewed the question of the influence of the pituitary gland on erythrocyte formation, and reports two interesting cases with an apparent definite polycythemia, one with a combined basophilic and acidophilic adenoma of the pituitary gland and the other with a malignant angio-mesothelioma of the adrenal. In the former the bone marrow was not examined and in the latter the pituitary showed basophilic hyperplasia and the bone marrow was hyperplastic. They brought forth no clear-cut evidence that in polycythemia vera there is derangement in this system. One can muster considerable evidence, however, for a relationship between the hypophyseal-hypothalamic system in polycythemia since numerous workers, including ourselves, have observed polycythemia associated with Parkinson's disease and brain tumors, the probable polycythemia occurring in Cushing's disease, and the failure of red cell production to slow down after oxygen breathing contrary to the situation in secondary polycythemia<sup>61</sup>. Schulhof and Mattihies<sup>97</sup> produced injury of the midbrain in rabbits and found that an increased red cell count developed, suggesting again that the midbrain plays a role in the regulation in the number of circulating erythrocytes. Recently in this laboratory experiments have confirmed the previously known fact that hypophysectomized animals will not respond to low barometric pressure and develop a secondary polycythemia as will normal animals<sup>27</sup>.

Cases of polycythemia appearing in several members of a family have been reported<sup>31</sup>, but this does not throw light on the nature of the process.

The diagnosis depends on the total clinical picture presented by the patient. A markedly elevated red cell count without obvious cause must be present, concurrent with a normal or near normal arterial blood oxygen saturation and an increased total red cell volume. An increased blood volume, per se, does not, as inferred by Haden<sup>33</sup>, permit one to differentiate polycythemia vera from the secondary polycythemia, such as those associated with congenital heart disease or pulmonary disease. This point is brought out in an article by Schafer<sup>95</sup> and has been shown in our studies<sup>4</sup>.

Isaacs<sup>50</sup> studied a patient with polycythemia vera having a markedly elevated red cell count and found that the blood viscosity as determined with an Ostwald viscosimeter was increased to 12.27 times that of water. He considers this to be about twice that of normal blood. As has been observed by others<sup>99, 116</sup>, he found the uric acid to be elevated (6.9 mg./100 cc.; in a repeat study, 8.59 mg./100 cc.) in this same patient. He comments also on the question of whether

in polycythemia vera there is increased production or decreased destruction of red blood cells. In his patient he found that the red blood cells were more resistant than normal to hypotonic salt solutions, hemolysis beginning at 0.3 percent and reaching completion at 0.2 percent. This suggested decreased destruction of red cells as a cause of the high red cell count in his patient. He also refers to the fact that in leukemia there may be an elevated uric acid content of the blood, which has been attributed to the nuclear metabolites of the white cells, but Schafer<sup>95</sup> also thinks that the high uric acid in his patient with polycythemia vera may be due to the "discarded" nuclei of the red cells. Isaacs and Christian<sup>18</sup> have both noted, that the reddish cyanotic appearance was apparently not directly associated with the increase in red cells. In a case of an anerythremic erythremia described by Morris<sup>77</sup> cyanosis was present, but the red cell count was not elevated. Christian noted in a group of ten cases of polycythemia vera the deep color was not always present. Some of the patients appeared to be pale, indicating that the depth of the color in the skin is due in part at least to the state of distention of the capillaries<sup>14</sup>. With reference to the cyanosis often observed, several investigators have studied the capillaries, the peripheral blood flow, cardiac output, and oxygen utilization in this disease. In one patient with polycythemia vera, Brooks<sup>11</sup> found that the cardiac output was only slightly increased, and since the blood volume was markedly increased it seemed certain that the circulation rate was slow. Blumgart<sup>10</sup> and co-workers studied the blood flow velocity and reported that there was a decreased blood flow in two patients with polycythemia vera. Altschule and co-workers<sup>1</sup> found the cardiac output and cardiac work to be normal in three patients at rest, but the capillary blood flow was slowed largely due to increased viscosity.

#### Incidence

The incidence of polycythemia is low but accurate information on this point is not available. It is, however, less than that of leukemia. Likewise, there is little information available on the prognosis after treatment. There have been several cases reported to have lived 10 or more years<sup>43, 58, 102, 121</sup> but there are only two adequate follow-ups or analyses of end results in large groups of patients. The closest approximation to a study of end results in a large group of patients is that of Tinney, et al.<sup>114</sup> in which it was shown that at least 36 patients out of 163 lived more than five years after onset. Videbaek<sup>121</sup> found that five years after diagnosis was made 85 percent of the females were living compared to 45 percent of the males. These patients were all treated by conventional methods including Roentgen rays, venesections, and phenylhydrazine. Stroebel<sup>106</sup> showed that at least 48 of 148 patients treated with P<sup>32</sup> lived more than five years after the onset of the disease. In general, the disease is recognized as one with a fatal prognosis and one in which thromboses are common<sup>12, 13, 78, 79</sup> so that life expectancy has been considered poor. Lee states, "The prognosis is inevitably fatal, but it must be remembered that this is a chronic disease, the duration of which varies from several months to many years. In the true form of polycythemia, the usual duration even after diagnosis, which is usually not established for over a year, is a number of years<sup>64</sup>."

### Treatment

Treatment has been removal of excess blood periodically by venesection<sup>42,103</sup>, destruction of excess red cells by such agents as phenylhydrazine<sup>28, 29, 53</sup>, or inhibition of red cell production by Roentgen irradiation to the spleen, long bones, or whole body<sup>86</sup>. Recently nitrogen mustards have been introduced into the therapy of polycythemia vera and the details of the treatment of ten cases are reported; but again there are no long term observations<sup>101</sup>. It is difficult to evaluate the comparative end results of any of these forms of therapy since there has been no large group treated by one method which has been followed long enough to determine the length of remission produced and the average length of life after onset or after beginning of treatment. A questionably effective method is the use of a diet low in iron. Recently several authors have advocated the use of a low iron diet in conjunction with either venesections or radioactive phosphorus<sup>19-23</sup>, although none advocated it as the sole method of therapy. In one patient Rosengart<sup>88</sup> found the low iron diet to be ineffective. It seems very probable that an iron deficient diet carried on for long periods of time might lead to a situation often observed in patients treated solely by venesection. The red cell count and total red cell volume remain high, but the hemoglobin falls to abnormally low levels making it unwise to further deplete the patient of iron. In connection with this it should be mentioned that a very low animal protein diet has been found to be quite effective in reducing the red cell count and hemoglobin in a significantly large number of cases<sup>41, 55</sup>. This diet also may be poor in iron but is certainly a deficient diet and for this reason is to be avoided.

### Pathology

At no place in the literature have we been able to find a comprehensive report on the pathology of polycythemia vera based on the study of a large number of patients. The relative rarity of the disease makes it difficult for any one individual or group to carry out such a study. The best general statements, however, (number of patients and blood status at the time of death not stated) are those of Zadek<sup>128</sup>, Gaisbock<sup>26</sup>, and Sternberg<sup>104</sup>. They reported a marked plethora at autopsy, all the organs being described as abundantly filled with blood.

In a careful review of the literature only isolated case reports describing the bone marrow were found. A number of authors (Moewes<sup>76</sup>, Glaessner<sup>30</sup>, Loew and Popper<sup>65</sup>, Schneider<sup>96</sup>, Luce<sup>67</sup>, Hutchinson and Miller<sup>49</sup>, Hamilton and Morse<sup>35</sup>, Bishop<sup>6</sup>) found replacement of the adipose tissue of the femoral marrow by blood-forming tissue as evidenced by gross and microscopic observations on single cases. Of the other bones studied, only the tibia (Watson-Wemyss<sup>124</sup>) and the humerus (Luce<sup>67</sup>) were specifically mentioned as containing hematopoietic marrow. Some authors (Parkes-Weber and Watson<sup>126</sup>) state that these findings occur in all the long bones.

1174510



Miller<sup>72</sup> reported five cases of polycythemia vera in which post-mortem examination disclosed myocardial infarction. Three had coronary occlusions, and although thrombi could not be demonstrated in the other two, the myocardial damage resembled that usually associated with coronary artery occlusion. Studies of the coronary vessels showed that in four of these five cases there was little or no atherosclerosis; or, if present, it was to a much smaller degree than would be anticipated on the basis of the age of the patients. It was thought that the coronary thromboses represented a manifestation of the thrombotic tendency seen in this disease and was unrelated to the degree of atherosclerosis. One of our patients on whom autopsy records are available died of an acute coronary thrombosis which had occurred 13 days earlier. In this case there was coronary atherosclerosis present. Lawrence and Rosenthal<sup>63</sup> reviewed the literature of the relationship between myeloma and polycythemia and reported four cases of polycythemia associated with myeloma. These added to the at least three previously reported cases make seven with this association<sup>85,100,109</sup>. Videbaek<sup>121</sup> has observed three cases of hypernephroma in a group of 125 cases of polycythemia and Forsell<sup>25</sup> reported one other case with this association. In this laboratory two cases of hypernephroma have been observed in association with polycythemia vera.

### Present Studies

Clinical, physiologic, metabolic, and therapeutic studies on 260 patients with polycythemia have been carried on in this laboratory, all directed toward a better understanding and treatment of this interesting condition. The group is made up of patients definitely having polycythemia vera, those having a relative "polycythemia" of unknown etiology<sup>59</sup>, and those having polycythemia clearly secondary to some other condition such as pulmonary or congenital heart disease or residence at high altitudes<sup>62</sup>. Except for a few patients with congenital heart disease and the subjects with altitude polycythemia however, most of these patients have been referred to us with the probable diagnosis of polycythemia vera, so the whole group does not give a true picture of the proportional incidence of the various types of polycythemia or relative polycythemia.

### Clinical Description

There are 201 patients in the first group (definite polycythemia vera). This report is concerned principally with the 159 patients on whom complete data were available at the time writing of this paper was begun. To qualify for this classification the patient must have had an unexplained elevation of the red cell count of 7,000,000 or higher when first observed by us, or there must have been definite evidence of this degree of elevation in the past. A combination of a definitely enlarged spleen with moderate or great elevation of the red cell count was considered diagnostic of the disease. Associated elevation of the platelet count and white cell count were considered as supporting evidence for the existence of polycythemia vera if the elevation of the red cell count was insufficient to establish the diagnosis.

1174511

A second group of 21 patients had relative polycythemia. In this group of patients, usually somewhat younger than the average polycythemia vera patient, there often was a mild elevation of the red cell count to perhaps 6,000,000 or 6,500,000 without a palpably enlarged spleen and without elevation of the platelets or white cells. In many of these there was a decrease in the plasma volume and in all no true increase in the total red cell volume<sup>59</sup>.

Finally, in the group of definitely secondary polycythemia, there was on clinical and laboratory examination clear evidence of cardiac, pulmonary, or other disease which could be reasonably ascribed as etiologically related to the polycythemia or history of residence at high altitude for relatively long periods of time. A fairly complete tabulation of the clinical and laboratory findings in these three groups of patients will be given in tables and graphs. Before discussing the physiological and therapeutic investigations carried out on this group of people, it seems of interest to describe them with reference to age, sex, race, color, history, physical, laboratory and other findings.

### History

With reference to the past and family histories of the polycythemia vera patients, it was found that 7 percent of them had a family history of polycythemia, leukemia, or pernicious anemia. In one family there was a brother (a physician) who had one sister with polycythemia vera and another with chronic myelogenous leukemia and a niece with polycythemia vera. The father of one patient died of polycythemia vera, and the brother, sister, and father of three others had pernicious anemia. Three others had leukemia in near relatives. Thus the familial incidence is low in this group of patients and its significance is not clear, although this question has been discussed by several authors<sup>31</sup>. In the group of relative polycythemia, there was no history of familial or other related disease, as, of course, was true of the small group of secondary polycythemia.

In the past history, there were several interesting findings, among which was the fact that 7 percent had a history of malaria years before. A history of exposure to fumes from oil, gas, or paint was found in 6 percent. One patient had been exposed to dust containing silica. In these patients there was no evidence of pulmonary physiological impairment. At the time of our first examination 6 percent were living or had lived at an altitude of 5,000 feet or higher. When a patient who resided at 10,000 feet altitude spent a few weeks at the seashore, the red cell count returned to normal, only to become elevated again on return to high altitude. Interestingly enough this patient (not treated by P<sup>32</sup> or x-ray) has an associated multiple myeloma which as yet has not produced marked bony changes. With reference to residence at high altitude as a possible etiologic factor, in a recent study in the Peruvian Andes we failed to find a patient with polycythemia vera listed in the records of the Cerro de Pasco Mining Corporation Hospital at La Oroya, Peru. For many years this hospital has served a large population of people living at

altitudes of from 12,000 to 17,000 feet. Other studies reported below add further evidence for the view that anoxia or hypoxia is not etiologically related to polycythemia vera.

### Symptoms and Signs in the History

The symptoms listed in decreasing order of incidence are: (1) headache, 45 percent; (2) dyspnea or orthopnea, 34 percent; (3) dizziness or vertigo, 28 percent; (4) eye complaints, 27 percent; (5) epigastric discomfort, 25 percent; (6) a definite history or diagnosis of peptic ulcer, 19 percent; (7) precordial chest pain, 16 percent; (8) pruritus, 14 percent; (9) thrombophlebitis of the veins of the leg or arm, 13 percent; (10) cerebral thrombosis, 10 percent; (11) gout, 7 percent; (12a) coronary thrombosis, 4 percent; (12b) thromboses other than cerebral or coronary, 4 percent; (12c) cancer or neoplasias, 4 percent.

Headache was the most common symptom. It varied in severity from mild and infrequent to intermittent and severe and varied in location from frontal to occipital. There is a definite tendency for many of these patients to have occipital headaches which radiate posteriorly down the neck. Some of them described headaches on awakening. The next most common symptom was dyspnea or orthopnea. In 97 percent of the patients with this symptom this was exertional dyspnea, and in 9 percent it was a mild orthopnea. In most instances the exertional dyspnea was mild to moderate. In a few both exertional and nocturnal orthopnea was present. Of interest in this connection is the apparently increased incidence of coronary occlusion among patients with polycythemia vera. Four percent of our patients had myocardial infarction. As noted above, Miller<sup>72</sup> observed that the complicating coronary thrombosis was frequently associated with little or no coronary arteriosclerosis. Pierce and Gofman<sup>81</sup> have studied the serum lipoproteins in 10 of the patients reported here and have found no pattern specifically different from those of a group of so-called normal people of similar age. The next most common symptom was dizziness, varying from rare to frequent episodes. The eye complaints consisted primarily in scotomata. The fifth most common was some complaint of abdominal pain varying from "chronic indigestion" to epigastric pain. This was a prominent complaint in 25 percent of the patients. Of these, 69 percent (28 patients) had peptic ulcers. In only two cases these could not be demonstrated by x-ray, however, the histories were clearly those of peptic ulcer. The ulcers were duodenal in 82 percent and gastric in 10 percent. Sixteen percent of the patients complained of chest pain usually brought on by exertion. The pain varied from "heart burn" to an atypical angina in a fifth of these patients. In the others the pain was not characteristic of any particular symptom complex. The eighth most common symptom was pruritus. In some of these patients there was an associated atypical dermatitis which was always unclassifiable by the dermatologist and which either improved or cleared up with therapy. In a few there were maculo-papular skin lesions which cleared up with therapy. There were 14 percent having arthritic complaints, and in

an additional 7 percent of the patients there was a definite history of arthritic complaint. Four percent of the patients had a history of thromboses other than cerebral or coronary. Two of the patients in our group had very extensive thromboses with onset before we saw them. One had a portal thrombosis and the other had multiple thromboses of the arm and abdominal vessels. Had their polycythemia been discovered and controlled earlier in the course of the disease, these complications might have been prevented, since in our treated patients the incidence of thromboses has been markedly lowered. With reference to the problem of gastric hemorrhage in cases of polycythemia vera, 4 patients (2.5 percent) had a history of gastric hemorrhage before we saw them. In 1 of these there was definite roentgenological evidence of a duodenal ulcer; in 1 there was x-ray evidence of hiatal hernia and a duodenal diverticulum; 1 had gastritis; and in 1 there was no evidence by x-ray of an ulcer. After the initial examination an additional group of 6 patients had a gastric hemorrhage of whom only one showed definite roentgen evidence of a duodenal ulcer. In the remaining 5 cases 1 case gave a history of ulcer symptoms for the past 15 years; in 1 case a duodenal ulcer was diagnosed; and in 3 there was no evidence of any type of ulcer. Thus, gastric bleeding in patients with polycythemia vera who are not under control is not a rare phenomenon. Also, sometimes there is no definite evidence of ulcer either of the stomach or duodenum. One case especially, had three episodes of massive bleeding from the stomach with vomiting of blood and the passage of tarry stools and yet never showed evidence of ulcer on repeated x-ray examination of the G. I. tract. Apparently the increased blood volume causes rupture of a small vessel and massive bleeding. It should be pointed out that the symptoms of the disease are varied and may be referred to practically any system of the body. On this account many of these patients were thought to be suffering from nervous exhaustion or neurasthenia, and the true diagnosis was not made for several years. Fatigue of some degree is a very common symptom of which we have not listed the incidence because of the obvious difficulty to evaluate such a symptom. Even though their red cell counts were markedly elevated a few patients were free of symptoms, and their condition was discovered more or less accidentally or during a routine physical examination.

In summary, the typical patient with polycythemia vera has a history of headaches, nervousness, scotomata, ruddiness of the face and mucous membranes, fatigue after moderate exertion, and may have had one or more thromboses in the arteries or veins.

Fourteen patients had red cell counts under 5.5 million at the time of the initial physical examination by us. The symptomatology was as follows: 57 percent had headaches, 42 percent had eye complaints, 35 percent had stomach complaints and vertigo, 7 percent had dyspnea, and none complained of chest pains. This group is small and total red cell volume determinations were not done on all of them. Some of this group may, even in the presence of relatively normal red cell counts, have had increased total red cell volumes. Improvement in or disappearance of all symptoms in patients treated with radioactive phosphorus will be discussed later.

Description of Cases

Figure 1 shows the distribution of age at onset of 159 patients with polycythemia vera. It shows that the first symptoms usually occur when the patient is 50 to 60 years of age. There are a few cases under 30 years and one over 80 years of age. When the age of onset is compared with age distribution of the general population, it is seen that although the age of onset is predominantly in the 50 to 60 year age group, the incidence of the condition is greatest in the 60 to 70 age group.

Fifty-seven percent of the patients were male and forty-three percent were female. The sex incidence ratio is 1.32. This is like that observed in chronic myelogenous leukemia<sup>60</sup>.

Figure 2 shows the variability of size of the spleen. In the majority of patients, the spleen was either not palpable or just palpable at the costal margin. There is a definite tendency however, for larger spleens to exist, although those being enlarged to below the umbilicus and into the pelvis constitute a small number of patients. It is important to remember that 90 percent of these patients were in hematological relapse with elevated red cell counts when first seen by us. Of those with palpable spleens 92.9 percent were in relapse, whereas in those who did not have palpable spleens only 84 percent were in relapse. Of interest in this connection is a study of 17 patients with polycythemia vera who did not have palpable spleens. By x-ray 41 percent of these patients had enlargement of the spleen. This demonstrates the fact that by percussion and palpation it is not always possible to detect splenic enlargement. Also shown in Figure 2 is the incidence of a pathological differential white cell count in these patients. The average white cell count together with blood volume and blood pressure will be referred to later in the discussion of the results of therapy.

The liver was palpably enlarged in 33 percent of the patients. However, as Figure 3 shows, when the liver is enlarged it is usually only barely palpable or 1 to 2 finger breadths below the costal margin. The not uncommon association of hepatomegaly and/or cirrhosis of the liver with polycythemia vera has been discussed by numerous authors<sup>115</sup>. We have observed this in at least three of our patients. However, it seems certain that usually the slight enlargement of the liver observed is on the basis of increased blood volume and consequent distention of the vascular bed of the liver.

Clubbing of the fingers, often seen in other forms of polycythemia<sup>62</sup>, was not present in these patients with polycythemia vera.

For purposes of discussion, the patients have been divided into two groups, hypertensive and normotensive, by criteria of systolic pressure greater than 150 and/or diastolic pressures greater than 90. So judged, 50 percent of the patients were hypertensive and 50 percent were normotensive.

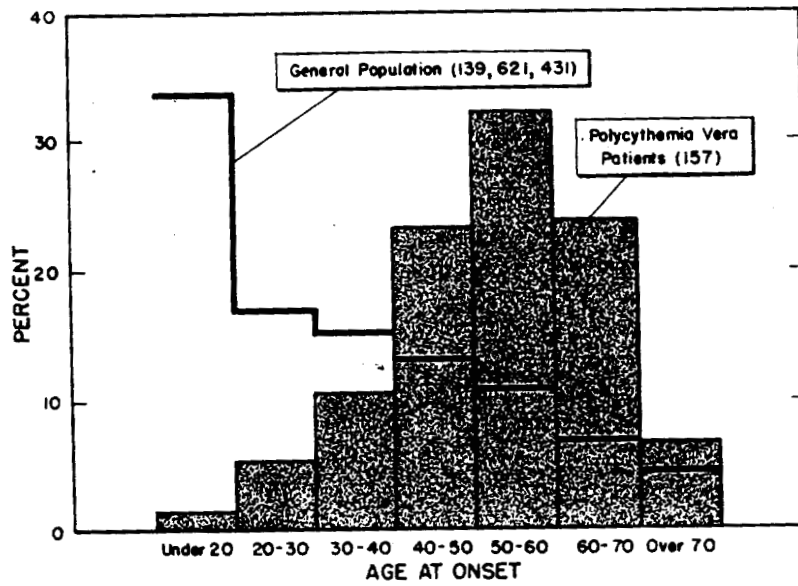

Figure 1: The age of onset of 159 patients with polycythemia vera contrasted to the distribution of age groups in the general population.

1174516

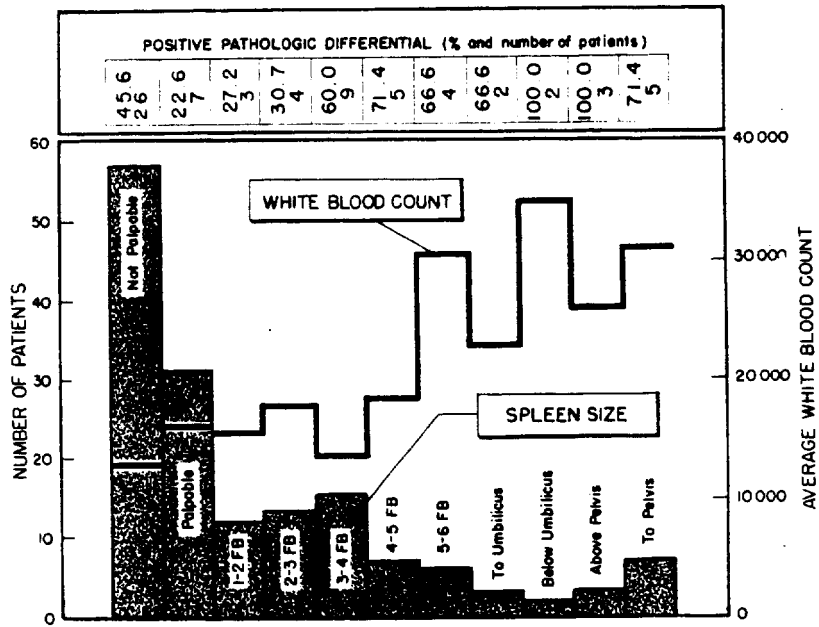

Figure 2: The Variability in the size of the spleen together with the white cell count for each level of splenic enlargement and the incidence of pathological differential white cell count in each group of patients.

1174517

31.1.11

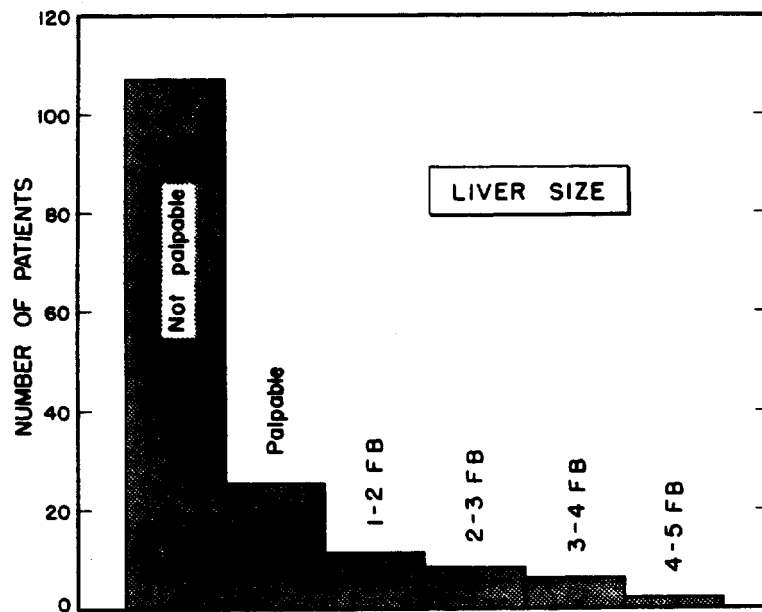

Figure 3: The variability in the size of the liver in polycythemia vera patients.



In Figure 4 we have analyzed the distribution of the systolic and diastolic pressures of these patients. It is seen that there is a definite tendency for an elevation of the blood pressure. Figure 5 shows the systolic pressure as a function of the red cell count, and Figure 6 shows the diastolic pressure as a function of the red cell count. There is no correlation between systolic pressure and diastolic pressure and the red cell count, the scattering of points being almost random in distribution. However, these results do not prove that there is no relationship between total red cell volume and the presence of hypertension in polycythemia vera<sup>82</sup> (this will be discussed below in more detail).

Figure 7 presents the white cell counts of these patients and those of 200 normal persons seen in this laboratory as part of a pre-employment health examination program. This shows that there is a distinct difference in the distribution of the white cell count of the patients with polycythemia vera as compared to normals. It is of interest to note that 28 percent of normal individuals had a white cell count between 10,000 and 15,000, with a few normals above this range. In polycythemia vera there is a distinct tendency for an elevation of the white cell count. Of the 40 patients who had white cell counts under 10,000 most had had previous therapy -- ten of these with P<sup>32</sup>, x-ray, or radium in sufficient quantities to influence the white cell count, and most of the others had been treated with phenylhydrazine or phlebotomy. It is not known whether phlebotomy will affect the white cell count, although a leukocytosis may result from phenylhydrazine. Seventy-four percent of the group had white cell counts over 10,000. Only five were over 50,000. The more one studies polycythemia vera the more he learns to expect an elevated white cell and platelet count in the untreated patient.

Figure 8 shows the distribution of the red cell counts at the initial examination by us. It shows that the largest group of patients have red cell counts between 7 and 8 million; although a large number have counts between 6 and 7 million. Of those patients with a red cell count below 6 million, 86 percent had had therapy during the previous six months with phenylhydrazine, P<sup>32</sup>, x-ray, venesection, or had had gastrointestinal bleeding of sufficient magnitude to produce a therapeutic response. Figure 8 shows the distribution of hemoglobin determinations in these patients. Here it is seen that the largest group of patients had a hemoglobin concentration between 15 and 20 gm./100 cc.; although there was a sizeable group with a hemoglobin over 20 gm./100 cc. Here again, just as for the red cell count, many of those patients who were in the lower range had had previous specific therapy or venesections.

Figure 9 shows the distribution of mean corpuscular hemoglobin, mean corpuscular hemoglobin concentration, and the mean corpuscular volume. The average mean corpuscular hemoglobin was 24.9  $\mu$ gm., the average mean corpuscular hemoglobin concentration 29 gms/100 cc. packed cells. These are slightly below the range of normal. Perhaps they fit in with the conception that certain of the polycythemic red cells are abnormal<sup>61</sup>. This will be discussed later under red cell life. The average mean corpuscular volume, 85  $\mu$  is approximately normal.

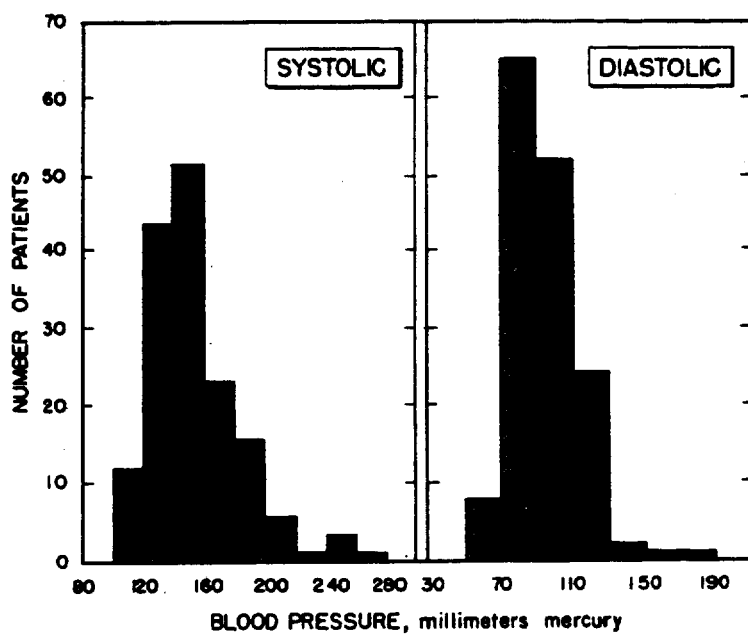

Figure 4: The distribution of the systolic and diastolic pressures in polycythemia vera patients.

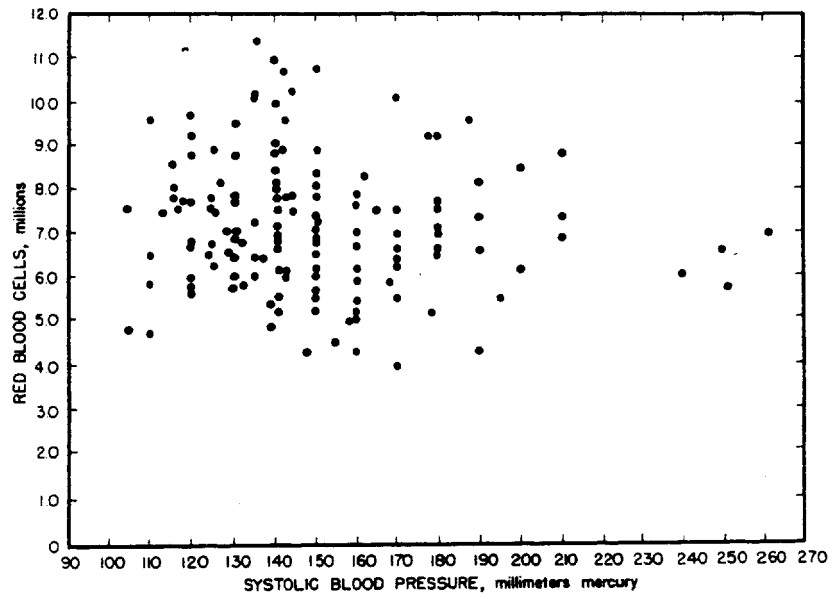

Figure 5: The systolic pressure as a function of the red cell count in polycythemia vera.

1174521

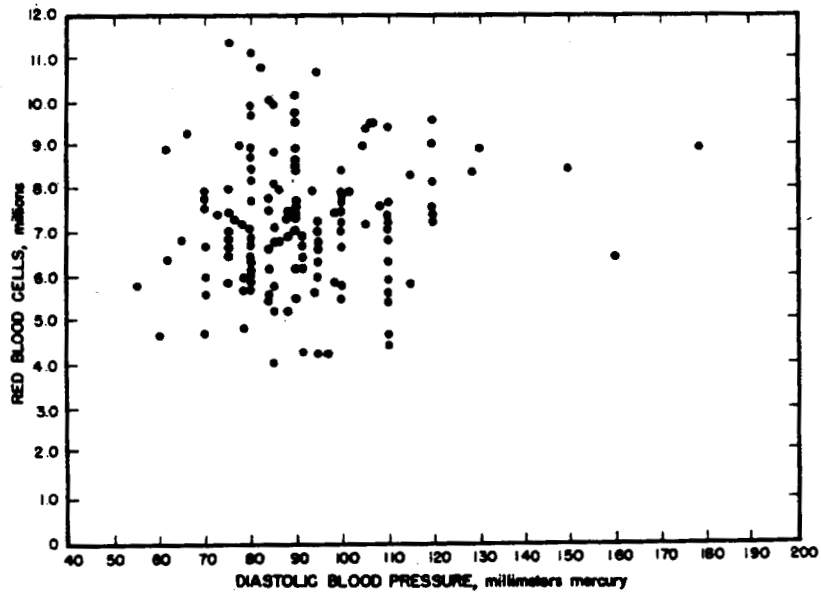

Figure 6: The diastolic pressure as a function of the red cell count in polycythemia vera.

1174522

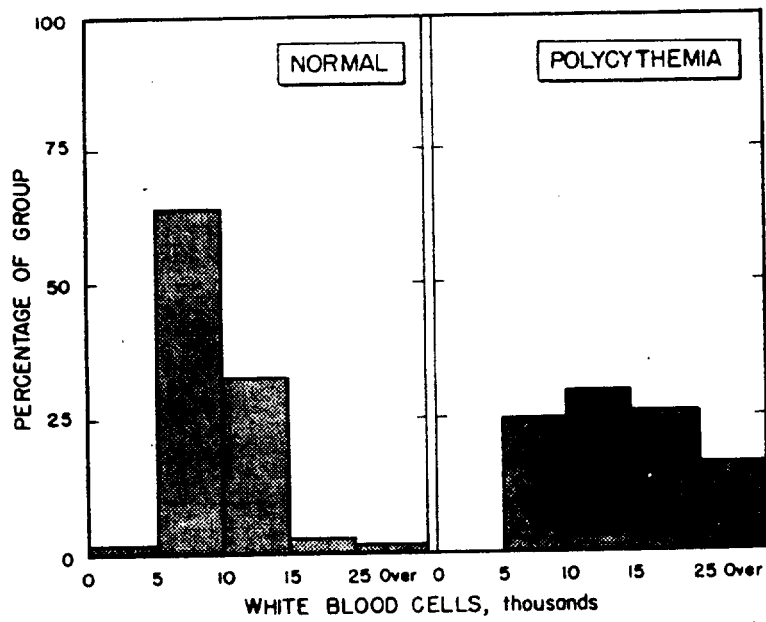

Figure 7: The white cell count in polycythemia vera patients and in 200 normals seen in this laboratory as part of a pre-employment health program.

1174523

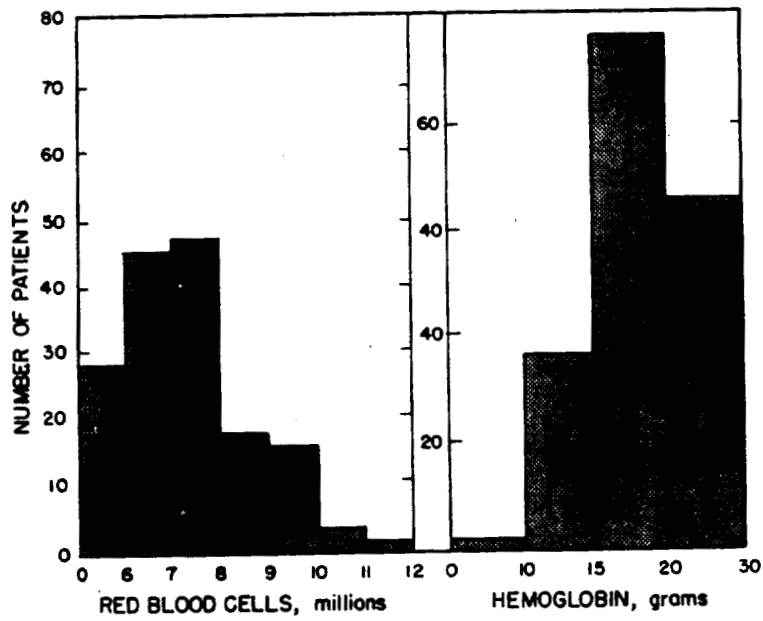

Figure 8: The red cell count and hemoglobin in polycythemia vera patients at the time of initial examination.

1174524

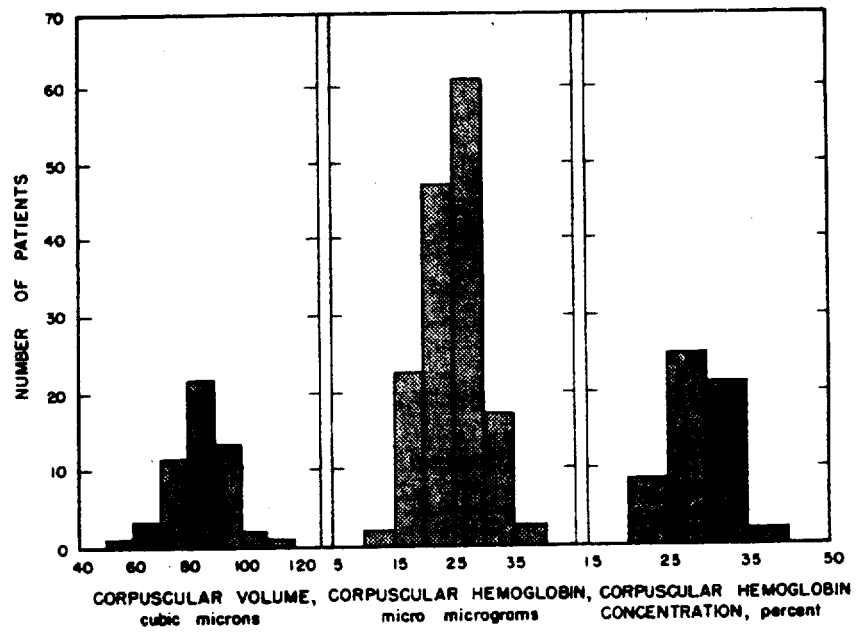

Figure 9: The distribution of mean corpuscular volume, mean corpuscular hemoglobin and mean corpuscular hemoglobin concentration in polycythemia vera.

In 35 unselected patients the coefficient of correlation between the total number of circulating white cells and the total number of red cells was 0.75<sup>4</sup>. There is then a total hyperplasia of the hematopoietic tissue, not an increase in red cell formation alone. This has not been well brought out in discussions of this disease in the literature. As stated above, Dr. A. S. Parkes-Weber, who has studied this disease for 60 years, recently told us; "People have generally failed to realize that polycythemia vera is a disease not only of the red cells but also of the white cells and megakaryocytes which are increased usually to an even greater degree than the red cells."

Figure 10 presents the platelet counts in these patients. It indicates the tendency towards thrombocytosis. Over 65 percent of the patients had a platelet count over 300,000, some ranging from 500,000 to 1,400,000. Again, recent therapy has modified the platelet counts in many of these patients, so that this figure may approach 100 percent in untreated patients.

In a group of 159 patients with polycythemia vera immature cells of the myeloid series, metamyelocyte to myeloblast, were observed in the peripheral blood of 111 patients when first seen by us. In addition, in 13 of these 111 nucleated red cells were observed. Forty-eight had no abnormal cells. Of the 111 patients having immature white cells of the myeloid series, in 49 the most immature white cell was the metamyelocyte, in 48 the myelocyte, in 8 the promyelocyte, and in 6 the myeloblast. Sixty-seven percent of the patients showing no immature cells had been treated shortly before we saw them. As we have pointed out previously<sup>58</sup> therapy markedly diminishes the incidence of immature white cells.

#### Other Laboratory Data

The NPN in 26 patients averaged 45.3 mgm. percent with a range of 26 to 66 mgm. percent. The total proteins averaged 7.59 gm. percent with the range of 5.7 to 10.12 in 38 patients. The A/G ratio averaged 1.24/1.00 in 37 patients with a range from 0.621 to 2.76. In 19 patients the serum bilirubin averaged 0.933 mgm. percent and ranged from 0.051 to 3.0. In 10 patients the fecal urobilinogen (three day stool sample) averaged 212 mgm. over a 24-hour period and ranged from 28 to 586 mgm. per day. All of the patients discussed in this paragraph were in hematological relapse at the time these tests were made.

In an unselected group of 97 patients some abnormality was found in the urine in 71. Sixty percent of the patients had pathological urines as exhibited by quantities of albumin ranging from a trace to 35 mg./100 cc.; 53 percent had occasional up to 50 red blood cells per high-powered field; 34 percent had anywhere from occasional to large numbers of white blood cells per high-powered field; and 30 percent had occasional casts either fine or coarse and granular. We associate these changes with varying degrees of nephrosclerosis, which is often found in patients in this age group and in patients with polycythemia vera at post-mortem. (See the following page.)



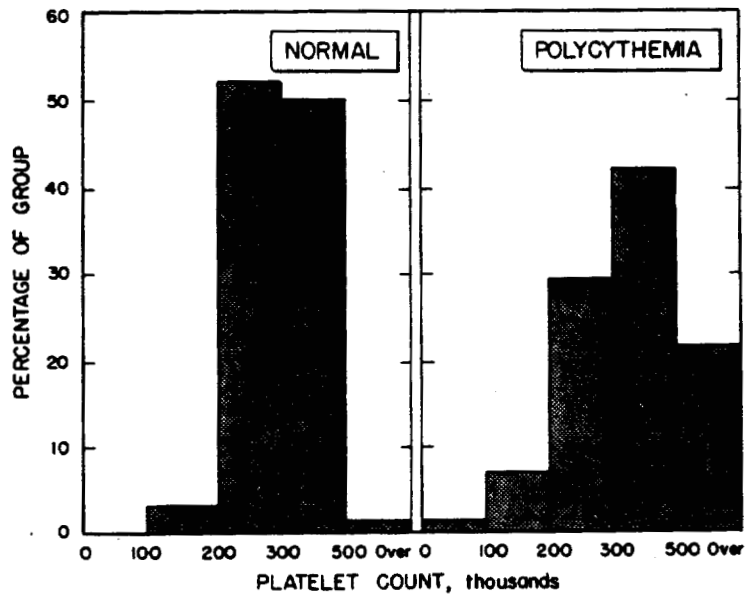

Figure 10: The platelet count in 200 normals seen in this laboratory and in patients with polycythemia vera.

1174527

398717

### Sternal Puncture Data

A study previously reported<sup>123</sup> analyzes marrow findings before, during, and after treatment with P<sup>32</sup> (Table I) and the average values of 20 normals. In comparison with the 20 normals, it is seen that there is a distinct increase in the number of nucleated red blood cells in the bone marrow differentials of patients with polycythemia vera, which is in general agreement with the findings of Manning<sup>70</sup>. However, the increase is not sufficient to be diagnostic and does not permit differentiation of polycythemia vera from secondary polycythemia. There is need for more marrow biopsy data from many parts of the marrow since polycythemia vera probably involves a change from fatty marrow to red marrow, involving both the red and white cell groups. The ideal way to study the bone marrow in this disease is by histological section after biopsy or sternal puncture. Block, Jacobson, and Bethard<sup>8, 9</sup> have found that in about 80-85 percent of the cases of polycythemia vera sections of the marrow from the sternum were diagnostic of the disease even though the patient had normal or subnormal hemoglobin values as a result of hemorrhage, phlebotomy, or treatment with phenylhydrazine and could be differentiated from cases of secondary polycythemia. These authors described the marrow as being hyperplastic with a replacement of much of the adipose tissue by hematopoietic tissue. The hematopoietic tissue showed a hyperplasia of cells of the megakaryocytic series and myeloid series and a tendency for cells of the erythroblastic series to occur in small clusters. Following treatment with P<sup>32</sup> these authors found in eight cases that the marrow was uniformly converted to a normal cellularity or slight hypocellularity, however, a slightly increased percentage of erythroblasts remained. Our investigation of the sternal marrow in 21 cases of polycythemia studied by such biopsy shows histological findings in agreement with those of Block and co-workers. We have likewise found that the effect of P<sup>32</sup> on the marrow is to reduce the total volume of hematopoietic tissue with a reversion of the marrow to a normal or almost normal architecture.

### Blood Volume

Blood volumes were determined by the P<sup>32</sup> labeled red cell method. The literature has been reviewed and the findings in 53 patients have been analyzed<sup>4, 82</sup> as follows: The patients were divided into three groups upon the basis of the hematocrit. Group I comprised 32 patients with a hematocrit of 55 or greater. Of this group, 30 had elevated total red cell volumes ranging from 38.8 to 93.9 cc./kg. of body weight. The other two patients had total red cell volumes of 31.3 and 34.9 cc./kg. of body weight. Twenty-two of the 32 patients had plasma volumes that were below the lower limit of normal. Of the remaining ten, eight had plasma volumes below the average, and two were above average and within the range of normal. Group II comprised 9 patients with hematocrits from 50 to 54. Seven had elevated total red cell volumes. In this group only three patients had low plasma volumes, five had normal plasma volumes, and one was above normal. In Group III, those with hematocrits below 50, the total red cell volume was normal in ten and low in two.

1174528

TABLE I  
Bone Marrow Findings on Polycythemia Vera Patients Compared with Normal Values

	<u>Normals</u>		<u>Pre-Treatment</u>		<u>Post-Treatment</u>					
	Average	Range	Average	Range	1-3 Months (4 Cases) Average	Range	4-9 Months (5 Cases) Average	Range	In Excess of 9 Months (16 Cases) Average	Range
Segmented	19.6	6.6-25.0	16.7	6.6-25.0	16.7	7.8-23.6	16.3	6.6-23.0	16.3	5.0-36.4
Band Cells	24.3	5.0-22.0	13.7	5.0-22.0	15.5	8.4-21.6	12.8	5.0-18.0	15.4	11.0-22.4
Myelocytes	20.8	9.8-32.2	18.4	9.8-32.2	19.5	12.0-27.0	18.0	9.8-25.8	23.4	14.6-41.0
Eos. Myelocytes	1.6	0.0-2.6	1.0	0.0-2.6	0.7	0.2-1.8	0.3	0.2-0.4	1.6	0.0-5.0
Bas. Myelocytes	0.04	0.0-0.8	0.3	0.0-0.8	0.3	0.0-0.4	0.2	0.0-0.6	0.2	0.0-1.0
Progranulocytes			2.1	0.0-11.4	3.4	0.0-9.6	6.2	0.0-11.4	2.2	0.0-6.0
Myeloblasts	2.2	0.2-2.8	1.0	0.2-2.8	0.8	0.4-1.4	1.2	0.6-2.8	0.9	0.3-5.0
Eosinophils	0.8	0.6-4.0	1.7	0.6-4.0	1.4	1.0-2.2	1.5	0.8-2.2	1.8	0.6-4.4
Basophils	0.02	0.0-1.0	0.4	0.0-1.0	0.1	0.0-0.4	0.5	0.0-1.0	0.4	0.0-1.0
Lymphocytes	11.7	0.5-8.7	3.6	0.5-8.7	6.5	2.4-16.5	3.2	1.4-5.4	3.2	0.6-5.8
Monocytes	0.4	0.0-1.6	0.4	0.0-1.6	0.4	0.2-0.6	0.2	0.0-0.8	0.1	0.2-1.0
Rubricytes	15.0	22.4-53.2	33.1	22.4-53.2	27.2	24.2-44.0	33.0	23.8-53.2	28.9	10.0-59.6
Prorubricytes	1.7	1.8-13.0	4.9	1.8-13.0	3.1	0.2-8.6	6.2	2.8-14.0	3.0	1.2-5.0
Rubriblasts	0.2	0.0-3.4	1.5	0.0-3.4	2.6	0.0-4.8		1.0-3.2	1.3	0.2-3.2
Plasma Cells			0.5	0.0-2.0			0.5	0.0-1.8	0.3	0.2-1.8
Megakaryocytes					0.8	0.0-0.8	0.1	0.0-0.4	0.3	0.2-1.0

1174529

0000000000

The only reliable measure of the number of red cells in the individual patient is the total red cell volume, not the red cell count, hemoglobin, or hematocrit.

The elevated blood volume in polycythemia vera in relapse is then due exclusively to an increase in total red cell volume. However, the blood volume is not increased proportional to the increase in red cell volume since the plasma volume is generally decreased. Polycythemia vera cannot be differentiated from secondary polycythemia by measurement of the blood volume. (See below)

### Viscosity

The viscosity was determined in an Ostwald viscosimeter and compared to water at the same temperature. Figure 11 shows the viscosity of the blood as a function of the red cell count in millions. The coefficient of correlation between the viscosity and the red cell count is 0.55 which is significant, indicating an increased viscosity of the blood. This may be of considerable significance in the pathogenesis of the thromboses seen in this disease.

### Life Span of the Red Blood Cell

With  $N^{15}$  labeled glycine London et al.<sup>66</sup> showed that the life span of the red blood cell was normal in one patient with polycythemia vera. In five patients studied by us following the administration of 100 microcuries of  $C^{14}$  labeled glycine there was a rapid rise in the specific activity of the hemoglobin followed by a fall and secondary rise. (See Figure 12.) This may be analyzed in terms of a population of cells consisting of both long lived red cells and short lived red cells. It is the rapid turnover of the short lived red cells which accounts for the large amount of iron utilized by these patients. (See section on iron metabolism.) Thus the data on iron metabolism and red cell life are compatible if one thinks of the cells as being divided into two population classes, one with a short life span and the other normal<sup>5</sup>. Our studies thus indicate the presence of an abnormal type of red cell in this disease.

### Iron Metabolism

Until the present studies on red cell life and red cell production were carried out with the aid of labeled iron and labeled glycine, there had been speculation regarding the nature of the abnormality in red cell metabolism which leads to the polycythemic state. Was red cell production increased or was red cell life increased? It is now clear that the gross and obvious abnormality of iron metabolism in polycythemia vera and secondary polycythemia is that associated with the increased production of red cells. Although there have been no reliable determinations of total iron in the normal human body, it is very probable that the amount does not exceed 4 to 5 gms., and it

1174530

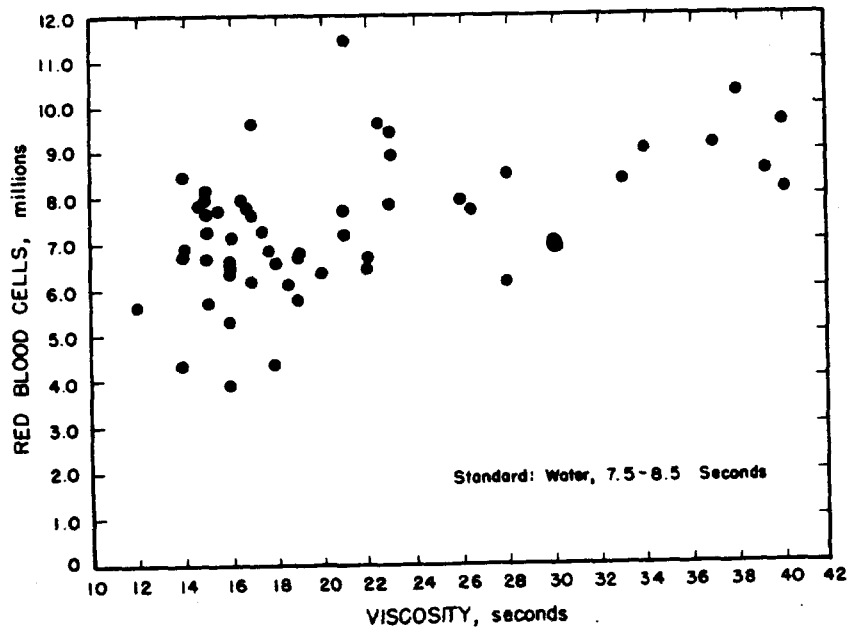

Figure 11: The viscosity of the blood as a function of the red cell count in polycythemia vera with a water standard varying from 7.5 to 8.5 seconds.

1174531

908.7.1

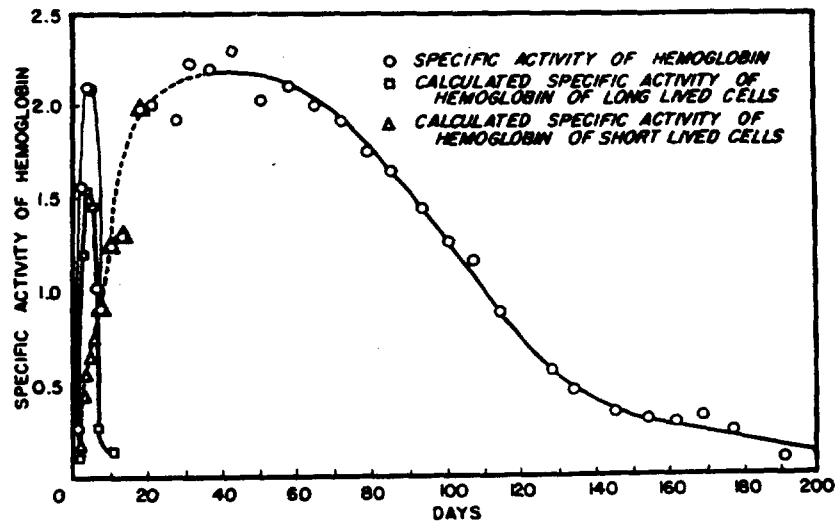

Figure 12: The specific activity of the hemoglobin in a patient with polycythemia vera following the administration of 100 microcuries of glycine-2-C<sup>14</sup>.

1174532

is more likely near 2.5 to 3 gms. A total red cell volume of two liters contains approximately 2 gms. of iron. The work of Finch, Haskins, and Finch<sup>24</sup> in which they were able to produce an iron deficiency anemia with only a few repeated bleedings indicates the relative lack of iron available for hemoglobin synthesis as well as the relative inability of the body to absorb adequate amounts of iron. From some of our Fe<sup>59</sup> studies (in vivo scintillation counters placed over the liver and other sites) of normal subjects there is evidence that the turnover for nonpigmentary hepatic iron is only 4 percent per day, with the implication that 100-300 mg. of such iron is present in the liver. Nonhemoglobin pigmentary iron (cytochrome, peroxidase, and myoglobin) constitutes another small fraction of the total iron.

The plasma iron amounts to 1 to 5 mg. depending upon the plasma iron concentration and plasma volume. It is the pool into which iron is "dumped" from the various cells and which furnishes an iron source for hemoglobin synthesis. This pool of iron is complexed with globulin (globulin IV - 7 Cohn) which limits the total quantity which may be present there at any time<sup>17, 44, 56, 83, 93, 94, 107.</sup>

This limited knowledge of the quantities of iron present in hemoglobin, plasma, liver, and the nonhemoglobin pigments furnishes a background for contrasting normal iron kinetics and those observed in polycythemia vera where the major iron compartment, hemoglobin, has been expanded as much as three times normal. If the rate of disappearance of the globulin IV-7 Fe<sup>59</sup> complex from plasma after intravenous injection in tracer doses, the total plasma iron, the percentage of tracer Fe<sup>59</sup> utilized in red cell formation are known, the percentage of tracer Fe<sup>59</sup> entering and leaving the plasma for red cell formation may be calculated. This has been found in the normal to average 20 mg./day<sup>95</sup>. However, in an untreated polycythemia vera patient this value may be as high as 200 mg. or more per day and is invariably elevated. This excessive iron turnover is due in part to the increased total red cell volume. However, the rate of replacement of red cells is greater than would be anticipated on the basis of a red cell life span of 120 days. This can be explained by the presence of a population of red cells with a shortened life span.

We have used the plasma iron turnover and red cell Fe<sup>59</sup> uptake in the diagnosis and management of polycythemia vera in several ways. Frequently patients are seen in which the diagnosis of polycythemia vera, or secondary or relative polycythemia is questionable. The total red cell volume may be increased 10-20 percent and the symptoms minimal. This arises from the fact that as yet we have no very good index for comparison of blood volume from one individual to another. The assurance to the physician and patient in knowing that there is likely to be no increase in the total red cell volume or that it will decrease, is valuable information which can be gained by plasma and red cell iron turnover studies. A second use which is made of iron turnover rates is in the assessment of the efficacy of therapy. Again because of the slowness of net changes in total red cell volume following treatment there

1174533

may be a tendency to give additional therapy when in reality the production rate is normal or below normal and will eventually bring about the desired

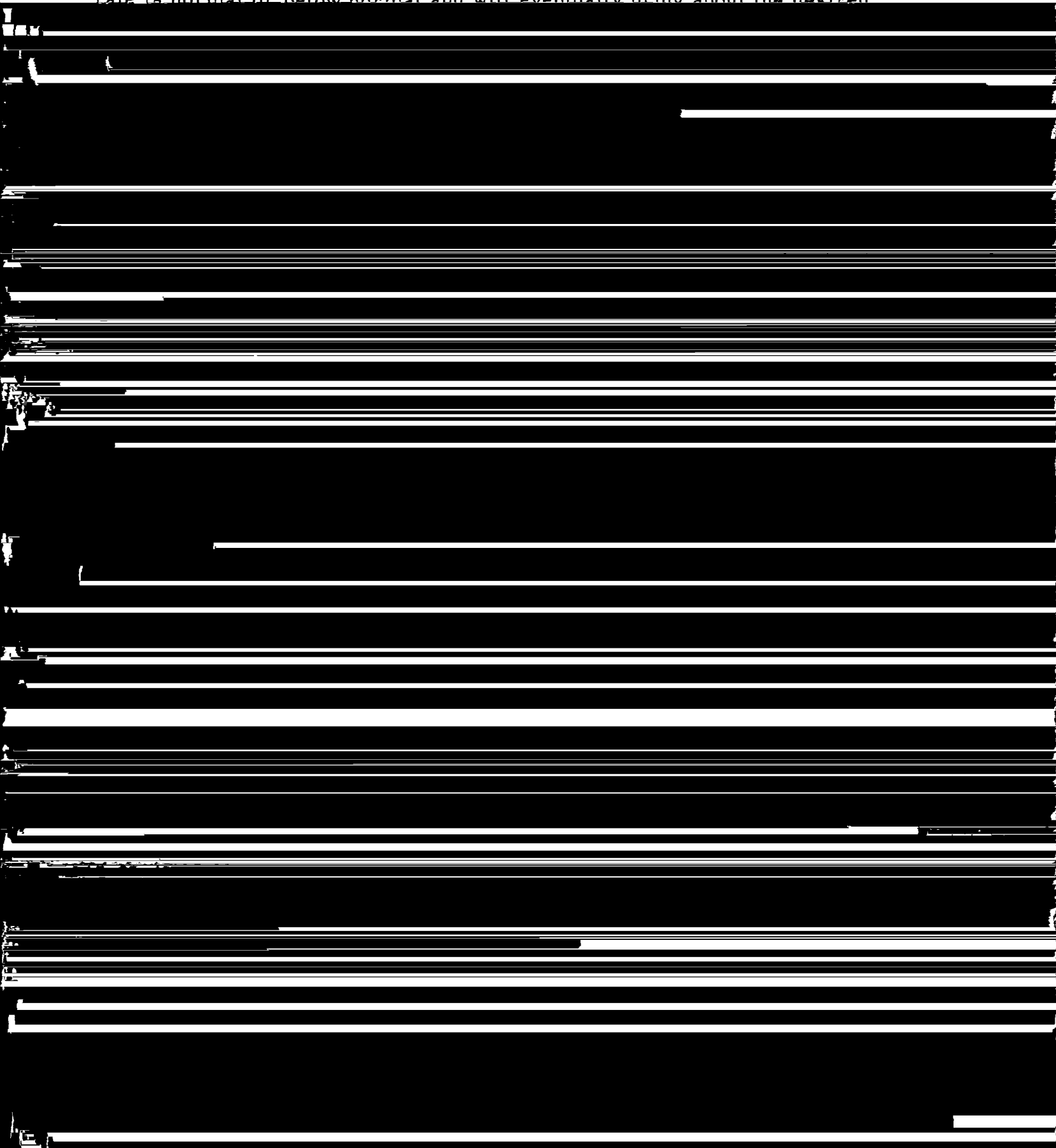



We have found the mean arterial O<sub>2</sub> saturation in 59 patients having polycythemia vera to be 92.2 percent as compared with 95.1 percent in 18 normals. Schwartz and Stats<sup>98</sup> found oxygen saturation of sternal marrow blood to be slightly higher in polycythemia vera than in controls, while Berk and co-workers<sup>3</sup> found no difference. There is thus no demonstrable bone marrow hypoxia in polycythemia vera, such as occurs in secondary polycythemia<sup>3</sup>. So it seems unlikely that anoxia is at the root of the disease. Also the concomitant increase in the number of white cells and platelets, the frequent concurrence of leukemia, the failure of 50 percent oxygen administration to depress red cell production as measured with Fe<sup>59</sup> 61, and the evidence for abnormal red cells<sup>5</sup> all point to the neoplastic-like nature of polycythemia vera and away from an hypoxic origin.

### Gas Exchange

As mentioned above Harrop and Heath<sup>39</sup> suggested that inefficient diffusion of gases across the alveolar membrane might be at fault. Studies from this laboratory on normal subjects, on patients with pulmonary disease, and on patients with polycythemia vera are of interest in this connection<sup>2, 51, 57, 86</sup>. These investigations have shown the decreased gas exchange rate (nitrogen, argon, krypton, xenon, and CO<sub>2</sub>) in patients with pulmonary fibrosis but yielded no clear-cut evidence that patients with polycythemia vera have any decrease which could not be explained on the basis of their age.

### Coagulability of the Blood

The paradoxical situation is present in patients with polycythemia vera, that there is both a high incidence of hemorrhage from various vessels in the body, such as cerebral and gastric vessels, and also a high incidence of thromboses<sup>12, 13, 68, 72, 78, 79</sup>. As is pointed out above, blood viscosity is increased and there is often an elevation of the platelet count. Routine studies of blood coagulability reveal no apparent abnormalities in clotting or bleeding times. Rosenthal, in our laboratory, studied<sup>91, 92</sup> blood coagulation in patients with polycythemia vera and obtained some very interesting data relating to the problem of thromboses and hemorrhage in this disease. In a group of 39 patients, 33 percent had histories of either thromboses or hemorrhage and 36 percent had an elevation of the platelet count above 400,000 when first seen by us. Thirty-one percent of the whole group had an increase in clot retraction rate, and in these 12, nine had platelet counts above 400,000. However, the clot is often fragile, imperfectly formed and dissolves easily and has poor retraction (See Figure 13). The rapid but defective clot retraction associated with the high hematocrit, elevated platelet count, and increased blood viscosity, is probably etiologically related to the frequent complication of both thromboses and hemorrhage. It will be pointed out later that these complications can be almost completely wiped out by proper marrow-inhibiting therapy directed toward the reduction of both platelets and total red cell volume. With the increased

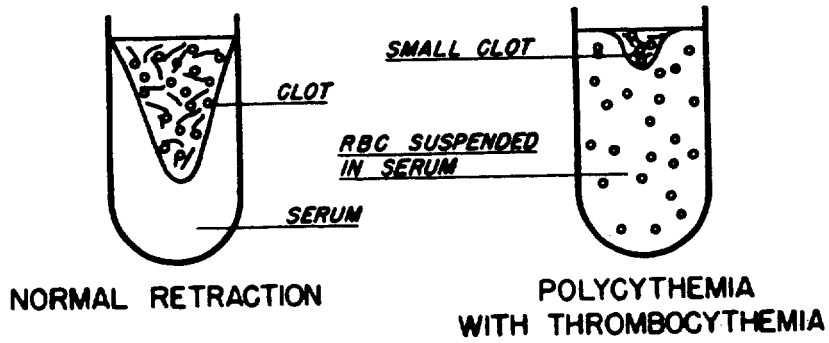

Figure 13: A schematic representation of normal clot retraction and clot retraction in polycythemia vera with thrombocytopenia.

1174536

blood volume and capillary distention it is not surprising that hemorrhage is common in these patients. Of interest in this connection is the observation by Miranda<sup>74</sup> that in inhabitants of the Alta Plano in Peru, who have large blood volumes, there is also an increased incidence of hemorrhagic phenomena, such as gastric hemorrhage and that from ruptured varicose veins.

### The Effect of Therapy on Symptoms

In general, practically all patients with polycythemia vera studied by us have been treated by either radioactive phosphorus alone (33 percent) or in combination with venesection (41 percent). In 60 percent of the total, P<sup>32</sup> was the first form of therapy given. A few patients have been handled by venesections alone, and these have usually been relatively young patients.

An analysis of 300 courses given to a group of 139 patients shows that an average of 6.68 millicuries of P<sup>32</sup> per course was given. A course of therapy consists in the treatment given over a six months period. Figure 14 shows the relationship between the initial white cell count and the dose of P<sup>32</sup> in millicuries required to produce a remission. It is obvious that there is no good correlation between the amount of P<sup>32</sup> required and the white cell count. Figure 15 shows the amount of P<sup>32</sup> in individual courses given to patients in this series. This graph shows that in the largest number of patients the dose was under 5 millicuries. In this group the dose averaged 3.01. However, there is a considerable-sized group requiring between 5 and 10 millicuries per course and in this group the dose average was 6.98. It is to be noted that there are smaller numbers of patients requiring from 10 to 15 millicuries per course, and a very small number of patients requiring from 15 to 30 millicuries per course.

Figure 16 presents an analysis of the treatment used. Venesections were usually carried out one or two days after P<sup>32</sup> administration in those patients with severe symptoms or those with thrombotic histories when it seemed desirable to bring down the total red cell volume to near normal levels within a short period of time. To do this, three or four venesections at frequent intervals were often necessary. Figure 17 summarizes the intervals and frequency of therapy with P<sup>32</sup>. The first graph is the interval between the last treatment and death in those patients who have died of their disease, the second is the interval between courses of therapy for all patients, and the third is the interval between the last treatment and June 1, 1952, for those patients who are still living. Analysis of this figure shows two distinct patterns. For those patients who are under active treatment, the largest group is re-treated within the interval of five to ten months following the previous course. The other two graphs show that for the deceased patients the average interval between courses of therapy had been 14.3 months. The average interval between the last course of therapy and death was 23.9 months. In the same group of deceased patients there were nine patients who were given only one course of therapy. In the living patients, of the 156

1174537

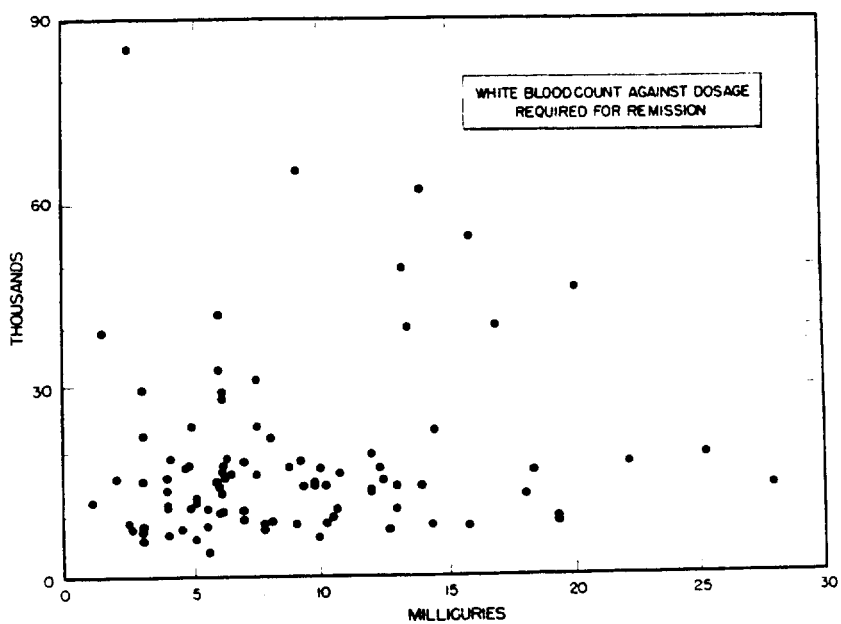

Figure 14: The amount of F<sup>32</sup> required for a remission as a function of the initial white cell count.

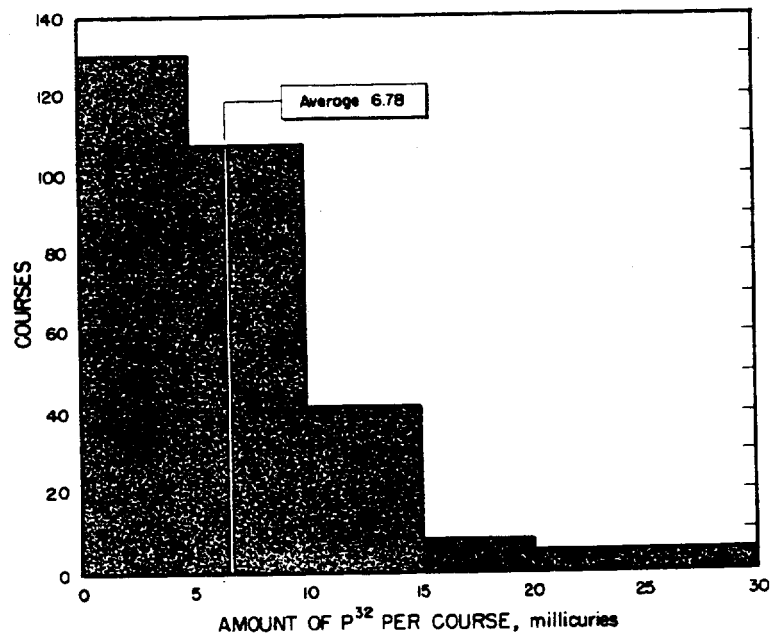

Figure 15: The amount of P<sup>32</sup> per course in polycythemia vera patients.

1174539

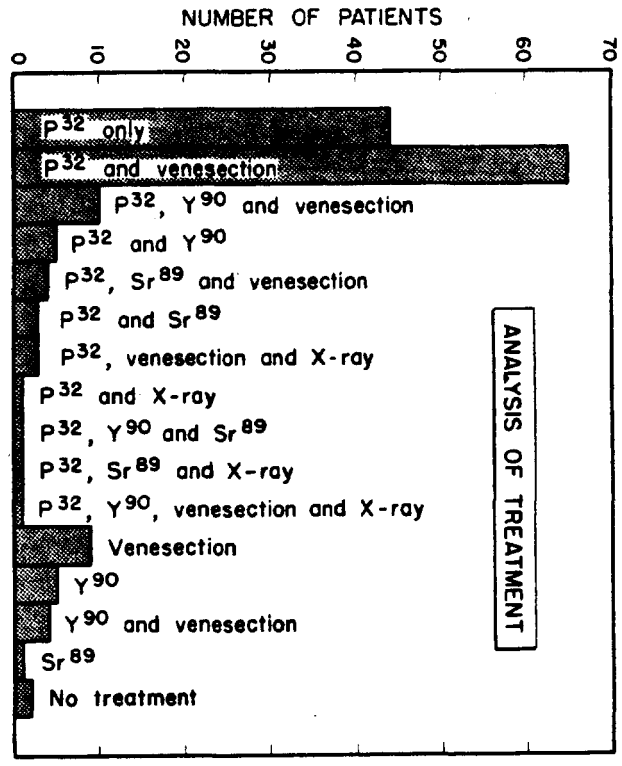

Figure 16: An analysis of the types of therapy used for the treatment of polycythemia vera in this laboratory.

1174540

courses of therapy given to 94 patients, the average interval between courses was 16.8 months. The average interval between the completion of the last course of therapy and June 1, 1952, was 32.8 months. Twenty-three patients received only one course of therapy. Figure 17 also shows that of those patients still living there are 20 patients who have gone five years since their last treatment, and five patients who have gone 10 years without requiring further therapy.

This analysis indicates that while under active therapy the average interval between courses is approximately 15 months, with the greatest number of patients being re-treated within an interval of six to ten months. Once the patient is brought into remission, the interval becomes much greater, of the order of approximately 33 months. For those patients who are still living this interval will undoubtedly increase since some of these patients will continue in remission. The difference in the average interval between courses of therapy and the interval between the last course and death or the last course of therapy and the time of writing merely reflects our plan of therapy. That is, when patients are initially seen, they are usually given a dose of 3 millicuries and observed for a period of three to four months and perhaps given a second dose three to four months later. Once active therapy has begun we do not push it to the limit but slowly bring the patient into remission. This may require from 12 to 18 months or in a few instances as long as two years before the red count is finally brought down to or below 5.5 million. This does not imply that no effect is seen immediately since the criterion for remission is noted as being 5.5 million. Many patients will be brought down from markedly elevated counts to levels slightly above this and then later gradually brought down into levels of complete remission. Thus, this difference is merely a reflection of caution in treating these patients and does not imply a necessity for frequent therapy. In a disease which usually has been long in developing we do not hesitate in most patients to take long to bring it under control. If we had given larger doses our figures of months between courses of therapy would be much greater.

Although the etiology of this disease is not known and if it is granted that some of the symptoms may antedate the increase in the red cell count and total red cell volume, it has seemed to us clear that most of the severe symptoms are due to the marked increase in the volume of blood especially of the circulating red cells. Certainly in the average patient, when the total red cell volume is brought back to normal, the symptoms of the disease vanish with the exception of a few, such as redness of the hands and feet in some cases, and other symptoms of a mild nature which one would expect to be present in a group of normal people in this relatively older age group.

It is, of course, obvious that in any group of people with an average age of 54, many of them will suffer from the various degenerative diseases such as atherosclerosis, hypertension, and cancer. The latter will be

1174541

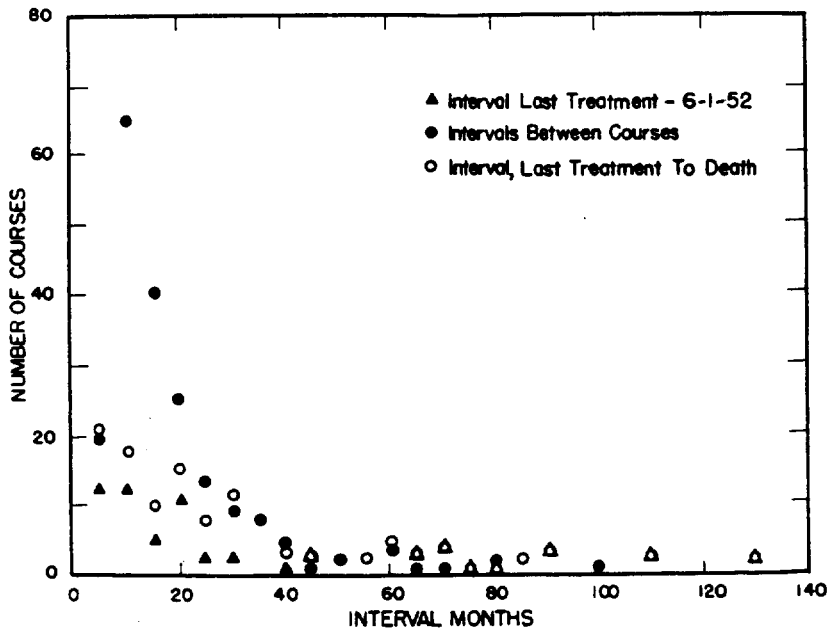

Figure 17: The interval between last treatment and June 1, 1952 for those patients who are living, the interval between courses of therapy for all patients, and in those patients who are deceased the interval between the last treatment and death.



discussed later under causes of death and life expectancy. However, with reference to hypertension, there seems to be at least two types, one unaffected by a decrease in the blood volume and the other affected or at least associated with the fall in the total red cell volume after therapy. These groups have been studied by Prentice, *et al.* from this laboratory and are discussed in more detail below<sup>82</sup>. Thus in the former group symptoms associated with hypertension, such as dizziness, ringing in the ears, and headache, would be expected to continue after the return of the total red cell volume to normal and probably accounts for many of the patients who do not experience relief after therapy.

In summary, the effects of therapy on symptoms are as follows: Symptoms have been classified as improving, remaining the same, or becoming worse. In the order of their frequency, i. e., headache first, it was noted that 92 percent showed symptomatic improvement, and 8 percent remained the same. With respect to dyspnea 81.5 percent improved, 13 percent remained the same, and 5.5 percent became worse; vertigo, 80 percent improved, 15.5 percent remained the same and 4.5 percent got worse; eye complaints, 85 percent improved, 5 percent remained the same, and 10 percent got worse; stomach complaints, 74 percent improved, 13 percent remained the same and 13 percent got worse; and precordial chest pains, 76 percent improved, 16 percent remained the same and 8 percent got worse. The details are available to any reader who wishes to see them. In general the patients who are reported here as being worse died relatively soon after treatment was initiated. In general the symptoms improve proportionally to the degree of return of the red cell count and total red cell volume to normal levels.

#### Changes in Physical Findings

Again, a group of patients whose red cell counts and blood volumes have returned to normal has been analyzed with respect to changes in physical findings.

In the group analyzed there were 99 patients with palpable spleens prior to therapy. As a result of therapy the spleens decreased in size in 86. This decrease in size was such that in 64 of the 86 it was no longer palpable. In 7 patients, the spleens did not decrease in size, in 4 there is no further record of spleen size, and in 2 it increased. In these latter cases, the increase was not large.

In 33 patients the spleen was not palpable at the time of initial physical examination and did not become palpable during the course of the disease; in 23 patients the spleen became palpable following the initial examination.

Further examination of the records of the latter 23 patients reveals that in 11 patients the spleen progressed from being nonpalpable to

1174543

being just barely palpable on deep inspiration. Thus, it is quite probable that in many of these 11 patients the spleen might have been palpable at the time of the initial physical examination and that it was a question of the examiner being unable to palpate it or thinking it was questionable. In 10 of these 11 patients the red cell count was significantly decreased at the time that the spleen became palpable and in one it was unchanged.

Of the 12 patients in whom the spleen did become palpable after the initial physical examination the red cell count was increased in 2 patients and in the remaining 10 patients a decrease was noted. It should be noted that in one of these patients, \_\_\_\_\_ whose record is given in detail, the association of palpability of the spleen occurred with the development of a chronic myelogenous leukemic phase of polycythemia vera. This is also true of three other patients, leaving eight in whom the spleen became definitely larger during the course of observations here but who did not develop leukemia. With reference to the 86 patients who had palpable spleens at the initial physical examination which decreased as a result of therapy with P<sup>32</sup>, in 70 the red cell count was decreased an average of 1.68 million, ranging up to 5.25 million, and in 16 patients there was an increase in the red cell count averaging 750,000 and ranging from 60,000 to 3.09 million. The former figure, of course, is not a significant difference between the blood count at the time of maximal decrease and that at the initial physical examination.

As a result of therapy the liver decreased in size in 23 patients (44 percent) in whom it was palpable at the initial physical examination. In 28 patients the liver became palpable during subsequent observation. Of these 28, 5 patients had an increase in red cell count, 22 patients had a decrease, and in 1 patient the report was not given. The increase in red cell count was never more than 710,000 and averaged 452,000.

The cyanosis, which was apparent in 96 patients, was improved as a result of therapy in 40. Ninety percent of these who improved showed an average decrease in the red cell count of 1.56 million and ten percent showed a slight, probably nonsignificant, increase in the red cell count averaging 340,000.

Fifty-two patients were hypertensive at the time of the initial examination. Following therapy with P<sup>32</sup>, in 27 there was a significant reduction in the blood pressure with the following changes in the red cell count: in 17 patients a reduction was noted, in one the change was not significant, and in nine the count was slightly elevated. There were six patients showing a reduction in both blood pressure and red cell count, three of whom received treatment with Y<sup>90</sup>. Gofman\* has shown that anyttrium colloid may be used for the treatment of polycythemia vera and is approximately equivalent in effectiveness, millicurie for millicurie, with P<sup>32</sup>.

---

\* Gofman, J. W., Symposium, American Medical Association, June 29, 1950.

In 23 patients who were normotensive at the time of the initial physical examination there was an increase in the blood pressure later to over 150/90. In nine patients the red cell count was either approximately at the same level or very slightly elevated, the maximum elevation being 800,000. In the other 14 patients there was some reduction in the red cell count although the blood pressure had risen. Two of these 23 patients did not receive Y<sup>90</sup> or P<sup>32</sup> and one patient did not receive P<sup>32</sup> but had Y<sup>90</sup>. Thus, both an increase and a decrease in the blood pressure can be seen with a decrease in the red cell count and blood volume.

### Hematological Changes

In 89 percent of the patients there was a satisfactory reduction of the red cell count, using a red cell count of 5.5 million as representing a remission, (for a typical example, see Figure 18.) A further breakdown in this group of patients showed that of 136 patients, 108 had red cell counts that fell to 5.5 million or less after the first course of therapy. Twenty-eight patients had a red cell count above 5.5 million after the first course of therapy. However, it should be further noted that of these 28, 50 percent had counts between 5.5 and 6.0 million and that there were two patients who died within one month following the initiation of therapy so that over 90 percent of the patients responded after the first course of therapy. It again should be emphasized that our conservatively small doses do not cause all of the patients to return to normal red cell values after the first course of therapy.

Prior to therapy, the white cell counts in these 159 patients ranged as high as 65,000 and averaged 16,900. During the first course of therapy, 68 of these had a reduction in count to the 5,000-10,000 range, 41 had counts which temporarily went below 5,000 and 16 continued to have counts over 10,000. In 34 of the cases the data are not complete enough for an accurate analysis to be made. The striking finding, of course is the increase in the number of patients with normal white cell counts and the conversion from an elevated to a normal count as the result of therapy with P<sup>32</sup>. Studies of patients in relapse showed that in only seven patients did the white cell counts rise significantly over the values observed during the previous course of therapy. In the majority the white cell counts did not rise to the same level as that which was observed during the initial examination.

Of the 68 patients who had a white cell reduction to the 5,000-10,000 range after the first course of therapy with P<sup>32</sup>, 49 had P<sup>32</sup> alone, 16 had P<sup>32</sup> and venesection, and 3 had P<sup>32</sup> and Sr<sup>89</sup>; of the 41 whose count went temporarily below 5,000, 24 had P<sup>32</sup> alone, 14 had P<sup>32</sup> and venesection and 3 had P<sup>32</sup> and Sr<sup>89</sup>; of the 16 whose count remained above 10,000, 10 received P<sup>32</sup> alone and 6 had P<sup>32</sup> and venesection combined as their first course of therapy. Of this entire group of 125 patients, 3 patients had a previous course of therapy with venesections or Y<sup>90</sup> and venesections which may have had some effect on the white cell count before they received their first course of P<sup>32</sup>.

PRIVACY ACT MATERIAL REMOVED

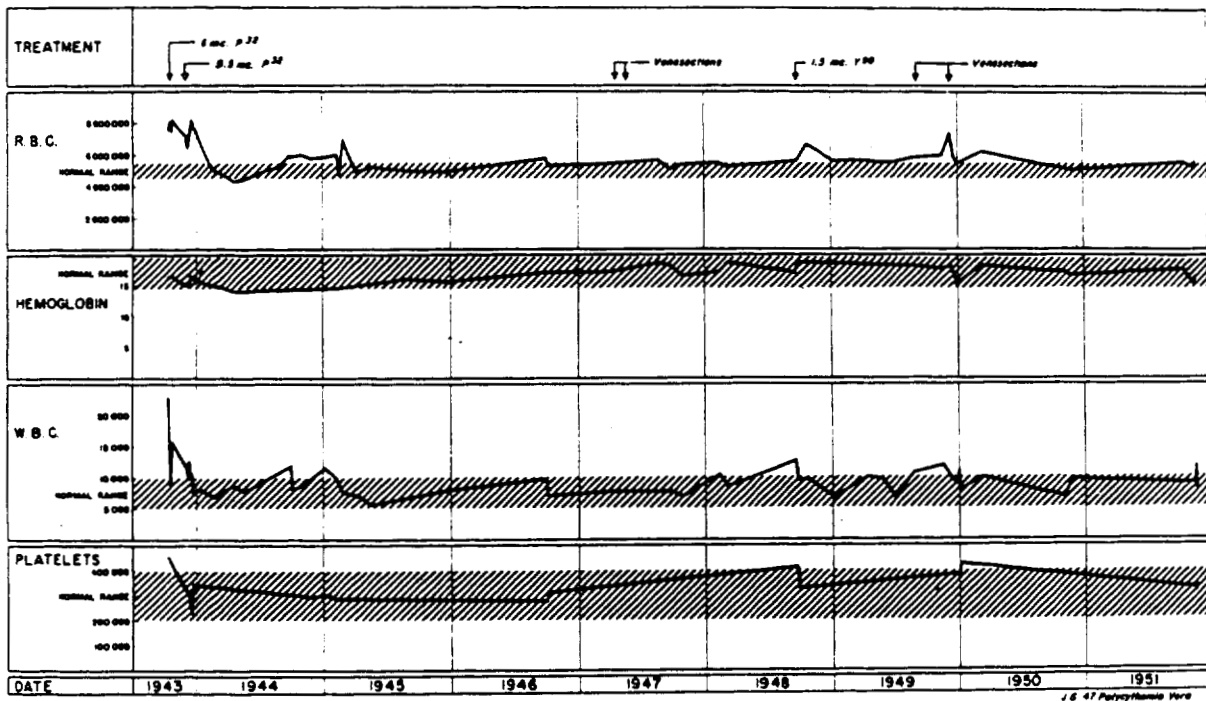

J.G. 47 Polycythemia Vera

MU 4230

Figure 18: The clinical course of Patient illustrating a typical remission in the red cell count following therapy with P<sup>32</sup>.

PRIVACY ACT MATERIAL REMOVED

1174546

With respect to the platelet counts we have arbitrarily chosen a level of 200,000 to 300,000 as representing normal. There were 27 within the normal range, 56 percent of whom had had previous therapy and 44 percent who did not; 14 below normal, 80 percent having had previous therapy and 20 percent did not; 68 above normal, 86 percent having had previous therapy and 14 percent who did not, and 50 on whom platelet counts were not done on the date P32 was administered. Following therapy there are satisfactory records on 97 patients: 35 (36 percent) were within the normal range, 57 (59 percent) were below normal and 5 (5 percent) were above. Thus, it is strikingly seen that both the white cell count and the platelet count are usually brought down to a normal range following therapy with P<sup>32</sup>.

With respect to the peripheral blood differentials, using as the criterion of a positive differential the presence in the peripheral blood of a cell of the myeloid series which was a metamyelocyte or less mature myeloid cell, 81 patients went from positive to negative differentials, five had metamyelocytes and showed no significant change, and six had myelocytes and showed no significant change. There was one patient with progranulocytes who showed no change and one patient with myeloblasts who showed no change. In four patients myeloblasts disappeared and only myelocytes remained, two patients went from myelocytes to metamyelocytes as the most immature cell, and two from progranulocytes to myelocytes as the most immature cell. Thus 89 patients showed significant improvement in the differential in the sense that there was a shift to the right, and 21 patients showed no significant improvement, 13 of the latter being the patients whose cell types remained essentially the same. This decreased incidence of immaturity of the white cell series following therapy fits in with the decreased incidence of leukemia observed in this group of patients (see below).

As a special study<sup>14</sup> 44 interval determinations of the blood volume were made in 20 patients with polycythemia vera over a period varying from 3 to 20 months. There were 12 males and 8 females in this group. There were two dominant patterns of change in blood volume, the frequency of which was approximately equal: (1) a parallel fall of total red cell volume and plasma volume, and (2) a fall in total red cell volume with a reciprocal rise in plasma volume. When the plasma volume rises reciprocally, the magnitude of change is considerably greater than in those cases in which it falls. The pattern of change does not remain constant in individuals, patterns 1 and 2 often appearing in the same patient. As a result of therapy, the changes in the blood volume showed consistently a decrease in the total red cell volume with the change in plasma volume either increasing reciprocally or decreasing. The resulting change in blood volume generally is a decrease.

Studies of groups of patients at various time intervals following the completion of therapy show that there is no significant change in the bone marrow at these intervals. The bone marrow differential in patients with a good response to therapy as compared with those who did not have a good response shows that there is no significant difference in the bone marrow differentials of the two groups. We have found the bone marrow puncture to be of little value in the diagnosis of polycythemia vera or in the management of these cases except in cases of leukemic transformation of the bone marrow.

1174547

### The Problem of Leukemia in Polycythemia Vera

Leukemia in patients with polycythemia vera has been frequently discussed in the literature<sup>58</sup>. Graham<sup>32</sup> found an incidence of 24 percent; Tinney, Hall, and Giffin<sup>112</sup>, 17 percent; Minot and Buckman<sup>73</sup> in a smaller series of 15 patients, 20 percent; Tischendorf and Herzog<sup>118</sup> in a series of 14 patients, 21 percent. These figures are minimal since in none of these groups have all of the patients been observed throughout the entire course of their disease. It thus appears to be clear that more than 20 percent of the patients with polycythemia vera have an associated leukemia or leukemoid blood picture. In the present study 62 of the 159 patients (39 percent) had a leukemic or leukemoid picture as evidenced by the presence of metamyelocytes, myelocytes, or myeloblasts in the peripheral blood, and 19 patients (12 percent) had both a leukemic blood picture and a white cell count above 20,000 prior to treatment. Four patients (2.5 percent) had a white cell count above 20,000 but no abnormal cells. In this connection we have observed that there is a direct correlation ( $r = 0.75$ ) between the number of white cells and red cells in polycythemia vera<sup>4</sup>. This disease is one involving both the white and red cell series. It is a disease in which a high incidence of leukemia or a leukemoid blood picture has been observed in the past and this is also seen in the present group of cases. As has been pointed out above, following therapy there is a marked decrease in both the number of white cells and the incidence of abnormal cells of the myeloid series in the peripheral blood. Also, in more than one half of those patients who had a rise in their red cell count subsequent to P<sup>32</sup> therapy there was no associated increase in white cell count and platelet count. Hall<sup>34</sup> reported 4 cases of acute leukemia occurring in 124 patients treated with P<sup>32</sup>. However, since the original report in 1948 these workers have not observed further cases of acute leukemia. Stroebel and co-workers<sup>106</sup> found that 12.5 percent of 32 patients not treated with P<sup>32</sup> died of chronic myelogenous leukemia. In the present group treated with P<sup>32</sup> 10 out of the 159 patients or approximately 6 percent died with leukemia. This appears to be a lower incidence of leukemia than reported in the other groups and is probably a result of the lowering white cell count and the improvement in the marrow architecture and the peripheral differential produced by P<sup>32</sup>. Thus, it should be pointed out that the incidence of leukemia in this group is low, and even in the group of relatively long duration it seems low. For example in the survival data of Videbaek the average survival was only 4.5 years in males and 7.3 years in females and 3 out of 76 died of leukemia<sup>121</sup>. Tinney and co-workers demonstrated, that in their group of long duration, i. e., in those patients who have lived 10 years or more, five out of eight cases (62 percent) died of leukemia<sup>112</sup>. On the other hand in our total group of 67 patients who have had polycythemia vera 10 years or more, only 13 percent have a leukemic picture and seven had died with leukemia. Thus it appears that the incidence of leukemia is certainly not increased as a result of treatment with P<sup>32</sup> and in all probability is decreased.

1174548

Life Expectancy and Causes of Death

The average age at onset in this group of 159 patients is 52. For those who have died during the last 16 years (53 patients, or 33 percent of the total,) the average age at death is 63. Many of the patients who are now living 10 or more years after the onset of this disease and who may have a total duration of 15 or 20 years will eventually increase this average life expectancy. (See Figure 19) Thus, the life expectancy is only a few years under the normal for this age group and is equal to that for diabetics treated with insulin and patients with pernicious anemia treated with liver<sup>37, 52, 119</sup>. There were ten patients who died with chronic myelogenous leukemia, of whom five died with chronic myelogenous leukemia terminating in acute leukemia, two patients had chronic myelogenous leukemia terminating in subacute leukemia when they died and the other 3 died with a picture morphologically like that of chronic myelogenous leukemia. Five patients died with a cerebral hemorrhage, one died with uremia, five with coronary occlusions and seven with congestive heart failure. Of the seven who died of carcinoma; one died of a melanosarcoma, one of carcinoma of the pancreas, 1 of multiple myeloma, 1 of prostatic carcinoma, 1 of cerebral carcinoma and two of hypernephroma. There were also five postoperative deaths recorded. This occurred in 1 case after a partial gastric resection, in 1 after an omental transplant, in 1 after amputation of the leg for gangrene, in 1 after splenectomy (this patient was in the myelogenous leukemic phase of polycythemia vera) and in 1 after perforation of the ileum following the freeing of intestinal adhesions which were producing an obstruction. In eleven patients we have no record as to the specific cause of death.

Before the introduction of P32 therapy<sup>106, 121</sup> approximately 50 percent of the patients died either of hemorrhage or thrombosis and carcinoma, leukemia and congestive heart failure were the other principal causes of death. In our group the incidence of death due to hemorrhagic and thrombotic phenomena is about one-half that reported by Videbaek and Stroebel, et al.; this decreased incidence is undoubtedly due to better control of the total red cell volume and platelet count counts in patients receiving P32, thus minimizing the danger of hemorrhage or thrombosis<sup>58, 91</sup>. In 8 patients with polycythemia vera of more than 15 years duration Tinney and co-workers<sup>114</sup> found that 4 of the 5 deaths recorded for this group were due to myelogenous leukemia. Thus, one can expect that in any group of patients with polycythemia vera who survive many years, a significant number of them will develop leukemia.

Table II summarizes the post-mortem findings in those patients examined.

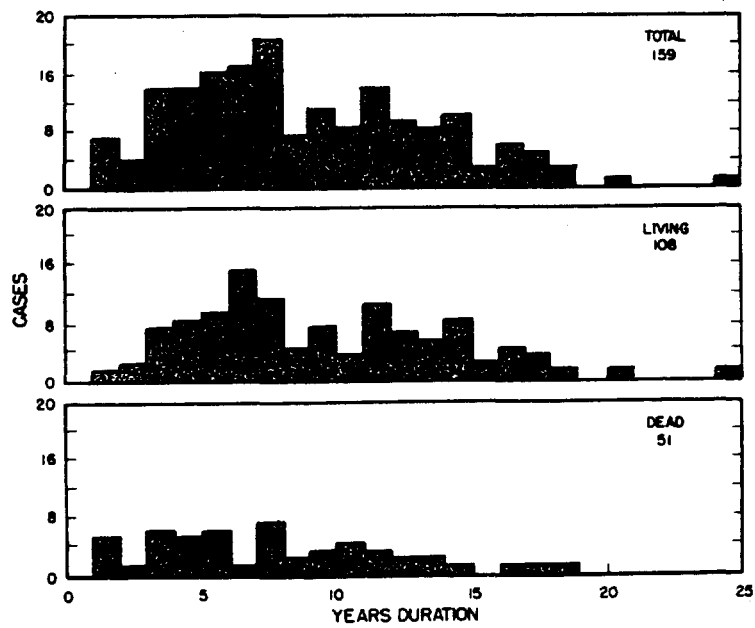

Figure 19: The duration after onset in 159 cases of polycythemia vera, 108 of whom are living and 51 whom are dead.

1174550





### Relative Polycythemia

Relative polycythemia is defined as an increase in the red cell count, hemoglobin, and hematocrit due to a low plasma volume, with a normal total red cell volume. This apparent increase in the number of red blood cells is seen in dehydration and also early after arrival at high altitude, although in the case of high altitude, the relative polycythemia is later replaced by an absolute polycythemia. We call this the relative polycythemia of anoxic stress<sup>62</sup>. It has been observed in a number of patients referred to us with a diagnosis of polycythemia vera.

The etiology of this condition is unknown; although, as will be pointed out, a significant number of the patients have neuropsychiatric backgrounds that would indicate unusual nervous stress or strain<sup>59</sup>.

There is no typical history. Some of the patients complained of dizziness, and about half of the patients were thought to have some significant anxiety situation or to be mildly psychoneurotic. This condition is found predominantly in the male. Of the 18 patients seen, 16 were males varying in age from 16 to 68 and averaging 39. On physical examination, 10 of the 18 patients were found to have the ruddy cyanosis characteristic of polycythemia vera. The heart, liver, and spleen were not enlarged. Fifty percent of the patients were overweight and 50 percent were hypertensive. The usual laboratory studies showed only an increase in the red cell count, hemoglobin, and hematocrit, but blood volume studies with P<sup>32</sup> labeled cells showed that in all these patients there was a pathologically low plasma volume. Studies of the rate of red cell formation with radioactive iron<sup>46</sup> showed that the rate of disappearance and the percentage uptake in these patients were much different from that observed in polycythemia vera, and the amount of iron utilized was compatible with that required for a normal red cell production rate. It is interesting to note that in these patients the white blood count is generally under 10,000 and that there are no abnormal white cells seen in the peripheral blood. The blood oxygen saturation was normal.

Follow-up studies of eight patients showed that over intervals of from six to twenty-four months, during which time the patients did not receive specific therapy and were not phlebotomized, no significant change in the blood volume occurred. That is, the patients continued to have the pathologically low plasma volume with a normal total red cell volume resulting in a hemoconcentration. Because of the fact that anoxic stress is known to produce a similar condition temporarily and because many of these patients were thought clinically to be under undue nervous stress and strain it is possible that this hemoconcentration may represent an effect of stress. From the standpoint of therapy these patients should not be treated with any agent designed to reduce the total red cell volume. Table III shows the pertinent findings in this group of patients.

PRIVACY ACT MATERIAL REMOVED

TABLE III  
Hematological Data of Relative Polycythemia Patients

Name	Age	Height	Weight	Obesity	Ruddy Cyanosis	cc/kg Body Weight-----										Date
						S.P.	RBC	Hgb.	WBC	Platelet	Blood Volume	T.R.C.V.	Plasma Volume	Hmt.		
1.	44	6'1/2"	96 kg.	+	+	130/85	6.54	18.1	14,900	270,000	51.8	28.5	23.3	55		
2.	43	72"	81.6	+	-	130/78	6.04	15.0	10,900	260,000	54.4 (4432 cc)	26.1 (2127 cc)	28.3 (2305 cc)	48		
			84.5			120/75	5.16	14.0	12,300	290,000	56.9 (4604 cc)	27.6 (2330 cc)	29.3 (2474 cc)	48.5		
3.	48	62-1/2"	56.7	+	+	260/140	6.82	17.4	10,200	380,000	45.4 (2578 cc)	25.0 (1418 cc)	20.4 (1180 cc)	55		
			53.4			210/135	6.02	16.7	9,300	320,000	52.7 (2812 cc)	29.0 (1547 cc)	23.7 (1265 cc)	55		
4.	39	6'4"	132.4	+	+	125/75	6.04	17.1	10,100	360,000	52.1	23.4	27.6	45		
5.	39	5'10"	93.2	+	+	155/115	7.35	17.5	8,000	240,000	52.4	24.7	25.1	51		
			91.0			126/80	5.46	16.9	8,400	360,000	49.0	29.4	19.6	60		
6.	39	69"	74.1	+	+	142/82	5.76	14.6	7,800	440,000	61.4 (4548 cc)	30.7 (2274 cc)	30.7 (2274 cc)	50		
			74.5			126/80	4.76	14.8	8,050	320,000	60.8 (4532 cc)	30.4 (2266 cc)	30.4 (2266 cc)	50		
7.	26	72"	76.8	-	-	140/80	5.78	16.6	6,600	320,000	54.4	28.4	25.6	52		
8.	41	5'7"	83.2	+	-	130/98	5.37	15.6	7,200	310,000	54.7	26.8	27.3	49		
9.	16	66-1/2"	65.5	-	-	110/62	5.68	16.8	7,308	390,000	55.6	27.0	28.5	49		
10	57	70-1/4"	99.5	+	+	120/80	5.24	17.8	7,800	260,000	58.6 (5837 cc)	32.8 (3268 cc)	25.2 (2509 cc)	56		
			95.5			135/80	7.16	18.1	8,300	220,000	60.5 (5782 cc)	36.3 (3469 cc)	24.2 (2313 cc)	60		
11	46	5'7"	81.8	+	+	124/98	4.96	14.2	15,500	150,000	57.7 (4716 cc)	28.0 (2287 cc)	29.7 (2429 cc)	48.5		
			81.8			5.5	17.0	9,400	150,000	57.7 (4716 cc) (5050 cc)	28.0 (2287 cc) (2190 cc)	29.7 (2429 cc) (2860 cc)	47.5			
12	32	5'10"	89.5	-	-	148/105	6.13	16.5	7,100	180,000	56.6 (5063 cc)	30.6 (3035 cc)	26.0 (2030 cc)	54		
			86.4			5.10	17.2	8,300	242,000	58.8 (5077 cc)	33.2 (2869 cc)	25.6 (2208 cc)	56.5			
13	47	72"	103.6	+	-	130/100	6.61	14.8	4,400	320,000	53.1	26.5				
14	33	66"	64.5	-	-	122/68	3.32	17.4	10,850	460,000	63.5 (4099 cc)	31.8 (2849 cc)	30.5 (1967 cc)	50		
			63.6			5.86	16.7	10,200	304,000	71.2 (4537 cc)	36.3 (2309 cc)	34.9 (2218 cc)	51			
15	63		47.9	+	+	182/98	4.95	17.5	15,000	300,000	52.6	27.8	25.6	51		
16	18		79.1	+	+	118/72	5.90	16.7	6,990	420,000	65.4	36.0	29.4	55		
17	46		40.1	-	-	160/100	5.95	13.1	11,000	340,000	59.4	28.5	30.9	48		
18	62	5'11"	76.82	+	+	165/85	5.79	15.8	7,130	260,000	57.7	33.5	24.2	58		

\* Second blood volume done by Dr. J. Statton, Evans Memorial Hospital, Boston, Mass.

MU-4465

PRIVACY ACT MATERIAL REMOVED

1174553

8854111

## Secondary Polycythemia

### A. Cardiac and Pulmonary Types

A total of 20 patients were studied. These were classified as follows: Six patients had congenital heart disease, five had a long-standing congestive heart failure with concomitant pulmonary physiological impairment, seven had noncardiac pulmonary disease, and two had rheumatic heart disease.

1. Cyanotic congenital heart disease: The six patients in this group all had cyanotic congenital heart disease and all but one were adults. The spleen was questionably palpable in one patient. With the exception of the one child, the red cell counts showed considerable elevation -- from 6.9 to 9.1 million red cells -- and marked elevation of the hemoglobin -- from 16.5 to 26 grams. Only one of these patients showed a white blood count above 10,000, and all had platelet counts within the normal range. In three patients the blood volume was determined and found to be markedly elevated with a total red cell volume between two and three times normal. All three patients had a considerable decrease in the plasma volume. In two patients iron turnover studies showed a red cell production from 2.3 to 2.7 times normal. The blood oxygen saturation ranged from 73 to 85.5 percent. Sternal puncture was done in six patients and is detailed in Table IV.

2. Pulmonary disease associated with congestive heart failure: There were five patients in this group, with red counts varying between 5 and 6.4 million at the time of initial observation and hemoglobins varying from 14.4 to 22.4. There was only one patient with a white cell count greater than 10,000. The platelet counts were within the range of normal. Blood volumes were determined on all five of these patients and showed an elevation of the total red cell volumes ranging from 38.8 to 57.4 cc./kg. There was a distinct tendency for a low plasma volume in these patients. Iron turnover in one patient showed a four times normal rate of production of red cells. The blood oxygen saturation varied from 80 to 95 percent. A satisfactory sternal puncture was obtained in one patient and is detailed in Table IV. The spleen was not palpable in any of these five patients.

3. Pulmonary disease -- noncardiac: The etiology of the pulmonary disease in these patients is as follows: One patient had a metastases from a carcinoma of the kidney, one as a result of a reduction in the amount of pulmonary tissue following a lobectomy, two had bronchial asthma of long standing, two were emphysematous, and one had pulmonary fibrosis. The blood volume was determined in all seven of these patients, and the total red cell volume found to be in the high normal range or slightly elevated in four -- from 32.4 to 38.2 cc./kg. of body weight; while three showed considerable elevation -- 57.6 and 58.1 and 58.8 cc./kg. There was a distinct tendency for a low plasma volume so that the hematocrits in all these patients appeared to be higher than would be anticipated

TABLE IV  
Sternal Marrow Puncture Data of Secondary Polycythemia Patients

Patient Date	24.4	25.4	11.6	13.8	10.0	23.6	13.2	33.4	24.4	12.8
Segmented Cell	24.4	25.4	11.6	13.8	10.0	23.6	13.2	33.4	24.4	12.8
Band Cell	17.2	13.0	11.2	15.2	7.0	17.0	8.4	16.0	11.6	9.2
Metamyelocyte	2.6	1.2	2.8	12.6	4.4	5.0	1.6	2.4	2.8	2.8
Myelocyte	9.0	11.2	16.0	13.2	7.6	14.8	8.8	19.6	14.0	14.6
Eos. Myelocyte	0.4	1.0	0.4	1.6	0.6	0.8		0.2	1.2	0.6
Bas. Myelocyte			0.2	0.3						0.2
Progranulocyte	2.2	7.0	4.6			4.2	0.8	2.4	3.8	3.6
Myeloblast	0.6	0.4	1.0			0.4	0.8	0.6	1.2	0.6
Eosinophil	3.2	2.6	2.8		1.4	2.2	0.6	2.4	3.4	1.8
Basophil	0.6	0.4			0.2	0.4	0.6	0.2	0.8	0.8
Lymphocyte	3.4	5.8	12.0	5.2	4.8	2.4	4.4	3.8	11.6	5.8
Prolymphocyte				4.2						
Lymphoblast				2.0						
Monocyte					1.4			0.6	0.4	1.6
Rubricyte	35.6	27.4	35.2	15.2	50.2	24.8	57.8	16.0	25.8	39.4
Prorubricyte	0.4	3.2	2.4	5.0	10.0	3.8	2.0	0.6	1.4	3.0
Rubriblast		0.4	0.2	3.2	2.2	0.4			0.4	0.2
Plasma Cell	0.4	0.6	0.6			0.4	1.0	1.2	0.6	2.0
Megakaryocyte		0.4		1.6		0.2				0.6

even from the total red cell volumes. The blood oxygen saturation was determined in six patients, and ranged from 42-91 percent saturated. In two patients it was 90.3 and 91. These latter two are at the lower border of normal and possibly may be even slightly below the lower limits of normal. Sternal puncture was performed on six patients and is detailed in Table IV. The spleen was not palpable in any of these patients.

4. Rheumatic heart disease: There were two patients with rheumatic heart disease. Blood volume was not determined in either patient. The blood counts were as follows: (1) RBC, 6.9; Hgb. percent 90; Hgb. gm. 13.0; Platelets, 520,000; WBC, 6,600; Retic. 0.5; Segmented cells, 45; Eosinophils, 7; Lymphocytes, 42; and Monocytes, 6; and (2) RBC, 6.99; Hgb. Percent 146; Hgb. gm., 21.17; Platelets 319,000; WBC, 12,000; and Retic., 1.5.

As a group these patients showed elevated red cell counts, normal white counts, and absence of a palpable spleen. Investigation of the blood volume showed elevation of the total red cell volume and a decreased plasma volume. The blood oxygen saturation was below normal. Figure 20 shows the relationship between total red cell volume and blood oxygen saturation. While there is considerable variation, the trend for a progressive increase in the total red cell volume with decrease in blood oxygen saturation is evident and of course expected. Iron turnover studies in this group showed a production rate that was several times normal but in general compatible with the total red cell volume assuming a normal red cell life span. This iron turnover pattern was unlike that observed in polycythemia vera, where the rate of production of red cells may be two or three times more than that required to maintain the total red cell volume if a 120-day red cell life is assumed.

#### B. Polycythemia of High Altitudes

Recently we have had the opportunity of studying in some detail the polycythemia secondary to residence at high altitude<sup>62</sup>. In the Alta Plano of the Andes there are over 164,000 people living between altitudes of 14,000 and 16,400 feet. The polycythemia of altitude is directly proportional to the height at which the individual lives. There is a concomitant increase in the red cells, hemoglobin, and total red cell volume proportional to the altitude of residence without the enlargement of the spleen or the increase in white cells or platelets that are so commonly observed in polycythemia vera. The first bone marrow study on such a group of people was carried out by Merino and Reynafarje<sup>71</sup> who demonstrated a marked increase in nucleated red cells, and we have confirmed this<sup>62</sup>. In our own studies three groups of subjects were studied (Table V): 14 healthy medical students from the University of San Marcos in Lima (sea level), Peru, made up one group; 11 normal natives living in the region of Morococha (14,900 feet), Peru, were the second

TABLE V  
Summary of Effects of High Altitude and Changes in  
Altitude on Hematological Values

	Normal Subjects		Morococha Natives		Morococha Natives (with pulmonary silicosis)
	(acclimatized at sea level)	(after ascent to 14,900')	(acclimatized to 14,900')	(after descent to sea level)	
Hgb gms/100 ml.	15.1 ± 0.8	16.5 ± 1.4	19.3 ± 1.9	18.0 ± 1.9	24.2
RBC x 10 <sup>-6</sup> /mm <sup>3</sup>	5.0 ± 0.4	5.5 ± 0.5	6.7 ± 1.0	6.0 ± 0.6	7.7
Hct.	45.0 ± 0.2	48.0 ± 3.0	57.0 ± 7.0	55.0 ± 0.6	77.0
Retic. Percent	1.5 ± 0.5	2.8 ± 2.0	1.7 ± 0.6	1.2 ± 0.5	---
Blood Oxygen Sat. Percent	97.0 ± 1.0	79.0 ± 5.0	81.0 ± 3.0	97.0 ± 1.0	---
Platelets x 10 <sup>-5</sup> /mm <sup>3</sup>	2.2 ± 0.6	1.8 ± 0.4	2.4 ± 0.8	3.2 ± 1.0	1.2
WBC x 10 <sup>-3</sup> /mm <sup>3</sup>	8.5 ± 2.1	9.5 ± 1.7	7.7 ± 2.2	7.2 ± 1.8	6.4
Staph. Percent	0.5	1.0	0.1	0.1	---
Polys. Percent	54.0 ± 7.0	63.0 ± 7.0	58.0 ± 9.0	57.0 ± 11.0	---
Eos. Percent	3.0 ± 2.0	3.0 ± 2.0	2.0 ± 2.0	4.0 ± 4.0	---
Bas. Percent	1.0 ± 1.0	0.5 ± 1.0	7.5 ± ---	7.5 ± ---	---
Lymph. Percent	38.0 ± 7.0	29.0 ± 6.0	35.0 ± 7.0	35.0 ± 11.0	---
Mono. Percent	3.0 ± 2.0	3.0 ± 2.0	5.0 ± 3.0	7.0 ± 2.0	---
Blood vol. cc/kg. body weight	70.7 ± 5.1	62.3 ± 6.7	85.9 ± 16.8	82.5 ± 16.8	94.3
∇ Nucleated red cells (marrow)	23.5 ±	32.0	29.9	21.0	---
Plasma Fe in γ/ml	1.8 ± 0.4	1.8 ± 0.6	1.8 ± 0.6	1.9 ± 0.6	2.5
Plasma Fe rate constant	0.54 ± 0.09	1.13 ± 0.33	0.68 ± 0.10	0.43 ± 0.25	1.93
RBC uptake Fe <sup>59</sup> Percent	82.0 ± 9.0	86.0 ± 13.0	88.0 ± 12.0	63.0 ± 23.0	69.0
Fecal urobilinogen mg/day	87.0	85.0	68.0		
Height cm.	168.5		162.8		161.0
Weight kg.	59.4		61.1		64.9
Age yrs.	23.0		19.8		42.0
Chest Diam. A. P. (cm.)	20.8		22.9		23.5
Chest lat. (cm.)	29.7		31.0		31.4
" circum. Rest. (cm.)	85.9		90.4		93.6
" " Inhal. "	91.0		94.1		97.0
Chest circum. Exhal. (cm.)	82.4		87.5		91.0

MU-4464

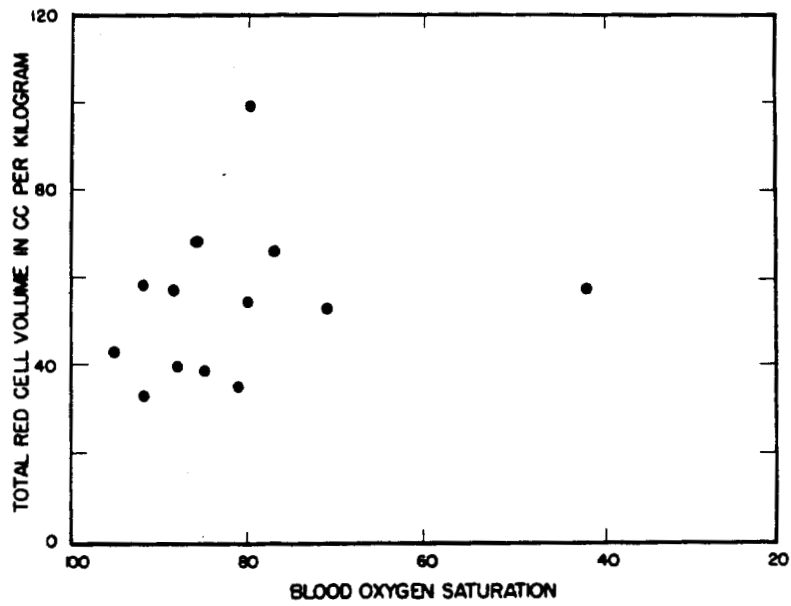

Figure 20: The total red cell volume as a function of the blood oxygen saturation in secondary polycythemia.

1174558



group; and the third group consisted of four native miners living at Morococha, Peru, who suffered not only from the polycythemia of high altitude but also from pulmonary silicosis. Each of the first two groups was studied in its normal habitat, and then all the studies were repeated at various periods of time after arrival of each group at a new altitude, that is at a lower or higher altitude. Examination of the chests of natives living at high altitudes showed chest measurements in all dimensions greater than those found in a similar group living at a lower altitude. These greater measurements were present in the position of full expiration, indicating some emphysema. The pulmonary second sound is consistently of greater intensity than the aortic second sound in these native Peruvian highlanders, and the chest x-ray films routinely show right heart enlargement. The electrocardiograms likewise show right axis deviation. The complexions of these people, although typical of their race, is accentuated by the pinkish-blue color of the skin and mucous membranes, not unlike that seen in severe cases of polycythemia vera. It was the impression of the industrial physicians working at these high altitudes in Peru that there is an increased incidence of peptic ulcer and of varicose veins among native highlanders, and also that it is their feeling that the life expectancy of these people is considerably less than for sea level dwellers. There is as yet no statistical study on life expectancy on these people.

Our peripheral blood findings confirmed those of Hurtado<sup>11</sup> and others. There is none of the associated hypertension in the polycythemia of altitude so often seen in patients with polycythemia vera. Also, unlike patients with polycythemia vera it is not unusual to find some slight clubbing of the fingers among the inhabitants of these extremely high altitudes.

Table V summarizes some of the hematological data on the native inhabitants of the Peruvian highlands.

Of course, unlike patients with polycythemia vera, people with high altitude polycythemia have decreased arterial oxygen saturation of the blood, which is the physiological reason for the polycythemia.

The effect of this decreased oxygen tension on red cell production is brought out very well in Figure 21 which shows the change in the plasma iron clearance rates in a group of young men shortly after arrival at high altitude, that is going from Lima, Peru, to Morococha, which is an altitude of 14,900 feet.

#### Case Histories

Patient :

This patient is a 59 year-old white male who was first seen here in July, 1945. At that time the history obtained was as follows: chief complaints were dizzy spells, aches and drawing feelings in legs

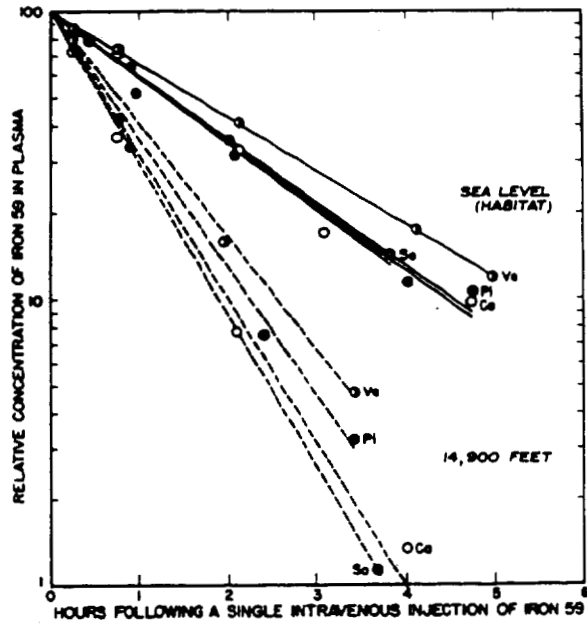

Figure 21: The change in plasma Fe<sup>59</sup> globulin complex clearance rates following ascent to a higher altitude.

and arms, swelling of the ankles, and a full feeling in the head which was not associated with true headaches, all of approximately 1-1/2 years duration. In 1944 severe cramplike pains arose in the back and in December, 1944 he first experienced dizzy spells. The symptom of chronic severe fatigue was severe enough at that time to make work impossible. On physical examination the patient had a ruddy cyanosis, congestion of the conjunctiva of the eye and of the mucous membranes of the mouth. The blood pressure was 145/100, the spleen was enlarged approximately 6 cm. below the costal margin and the liver was felt approximately 4 cm. below the costal margin. There was a pitting edema of the left ankle and foot. The blood counts and therapy are detailed in Figure 22. The patient received venesections totaling 1500 cc. and approximately 9 mc. of P<sup>32</sup> during his first course of therapy. This therapy produced a satisfactory reduction in the red cell count, hemoglobin, white cell count, and platelet count until March, 1951. (Further effort to contact this patient since then has not been satisfactory.) In October, 1948, this patient was almost asymptomatic on physical examination. He was not cyanotic, the blood pressure was 124/82, the spleen was palpable only 3 cm. below the costal margin and the liver 4 cm. below the costal margin, and there was a non-pitting edema of the left ankle. This is an example of a patient who has had a very satisfactory and long remission, lasting over 6 years, following 1 course of 9 mc. of P<sup>32</sup> and phlebotomies of 1500 cc.

Patient :

This 52 year-old white woman was first seen here March 2, 1945. The history obtained showed the patient had gradually been feeling worse since 1935 or 1936. She noted heaviness and aching in her arms. She had always been flushed in the face and in 1937 noted that her face had become blue and that there was a large hematoma of the left eyelid. In the early part of 1938 the condition of the patient was diagnosed as polycythemia vera, the red cell count at that time varying between 7.5 and 9 million, and thereafter until 1945 the patient was treated with frequent phlebotomies averaging about once a month; she had also had phenylhydrazine. In 1944 x-ray therapy to the spleen was given with symptomatic improvement, however, approximately 3 months after the x-ray the spleen enlarged to an even greater size.

At the time the patient was seen here the principal complaints were headache and nervousness. Review of the systems showed that the patient's memory was poor, and she was emotionally unstable, given to crying. There was aching in the arms and legs which was relieved by aspirin. On physical examination the patient was described as being thin, plethoric woman in no obvious distress. The spleen was enlarged, filling the entire left upper and lower quadrants and extending beyond the midline into the right upper quadrant and right midquadrant. It was slightly tender. The liver was not palpable. The initial blood counts are shown in Figure 23, together with the therapy administered. By May 5, 1945 the patient

1174561

PRIVACY ACT MATERIAL REMOVED

S664111

PRIVACY ACT MATERIAL REMOVED

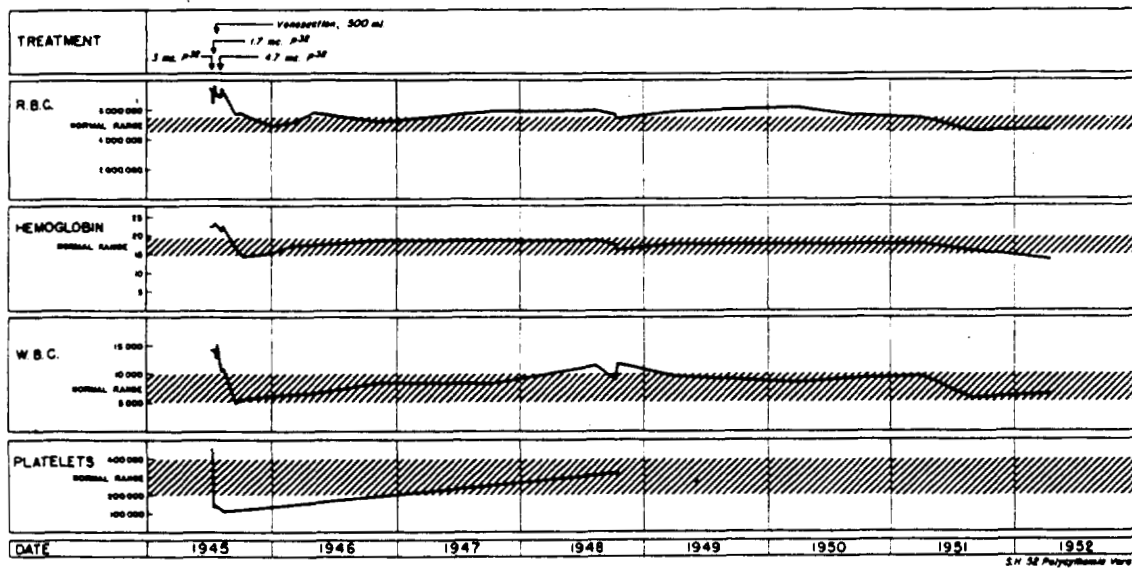

MU 4229

PRIVACY ACT MATERIAL REMOVED

Figure 22: The clinical course of Patient

1174562

PRIVACY ACT MATERIAL REMOVED

M.D. POLYCYTHEMIA VERA (Female, Age 45)

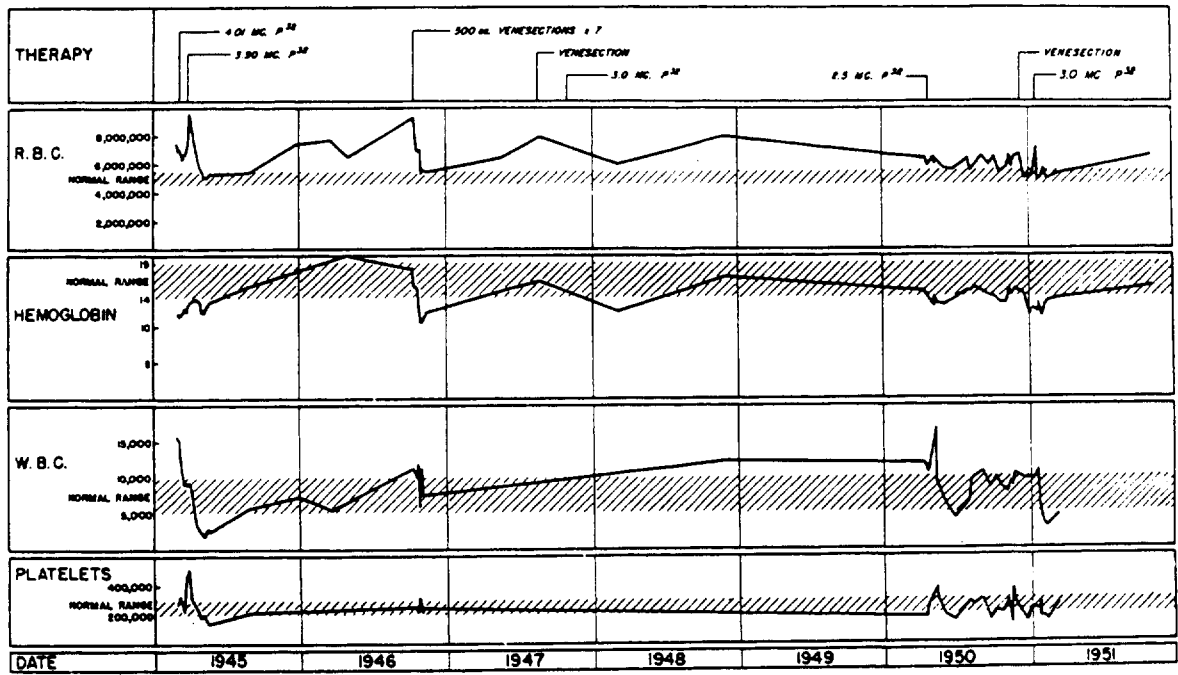

MU4226

PRIVACY ACT MATERIAL REMOVED

Figure 23: The clinical course of Patient

1174563

103.7.1

had noted that there was considerable symptomatic improvement with both subjective and objective evidence of considerable decrease in the size of the spleen. At the same time, a leukopenia had developed. By May the spleen was palpable 2 cm. below the costal margin.

The patient returned in October, 1946, by which time the red cell count had risen to the 9 million level and the white cell count was over 10,000 but the hemoglobin and platelet counts were within the normal range. The spleen had enlarged to the midline and to the level of the umbilicus. The patient was treated with seven venesections at that time with a satisfactory reduction in the red cell count and hemoglobin but no significant change in the white cell count and platelet count. The patient was not seen here between November, 1946, and March, 1950, although her referring physician reported her clinical status and blood counts at frequent intervals. As Figure 23 shows this patient did not require radioisotope therapy during this interval.

The patient returned again in March, 1950, having been controlled in the interval largely with venesections. Beginning in November, 1949, she had again begun to be fatigued which forced her to quit her work as a salesclerk in a department store. She complained of frontal and occipital headaches and pain in the eyes. Symptomatically there was a mass present in the left upper quadrant which apparently was an enlarged spleen. There was slight exertional dyspnea and swelling of the ankles in the late afternoon. On physical examination the spleen was found to be enlarged to the level of the umbilicus and to the midline. In April, 1950, the patient had an unusual neurological episode described as follows: She could not use her hands, they felt numb, and her throat felt constricted so that she could not speak. She also noted a sag in the right facial muscles and her local physician later stated she had had a slight "stroke." These symptoms largely cleared during the first day and had disappeared three to four days later. Physical examination two weeks later revealed a definite mild paresis of the facial muscles on the right, and a slight deviation of the tongue to the right. The patient then began to have attacks of vertigo. Later in 1950 the vertigo, hyperventilation, and the same tight sensation in the throat recurred but cleared spontaneously in a matter of hours. In the latter part of 1950 the patient had an ophthalmic stomatitis which responded very satisfactorily to antibiotics. Three months later following the administration of 3 mc. of P<sup>32</sup> on January 18, 1951 the patient was considerably improved symptomatically and went east.

This is an example of a relatively typical treatment with reduction in red cell count, white cell count, and platelet count and with considerable decrease in spleen size.

#### Patient

The patient is a 54 year-old white male first seen here in July, 1941. In 1938 following trauma, it was noted that the patient had an elevated blood count. Three to four months after surgery for this trauma

he began having aches and pains in his feet and his eyes began to bother him with blurring. A diagnosis of polycythemia vera was made in October, 1939, and he was treated by phenylhydrazine and phlebotomy until 1941. At the time the patient was first seen here neither the spleen nor the liver was palpable, and there were no significant physical findings other than a florid complexion. In July, 1941, he was given 5 mc. of P<sup>32</sup>. His course, the peripheral blood counts, and therapy are detailed in Figure 24. In June, 1948, the patient reported that for the previous 6 months he had some soreness and sharp pain in the region of the left epigastrium which became worse after intake of alcohol and was not relieved by food. Since the elimination of alcohol at that time this pain has been decreased. The spleen first became palpable in July, 1949, extending 4-6 cm. below the costal margin. At that time the patient had a hematocrit of 38, with a total red cell volume of 21.8 cc./kg. body weight and a plasma volume of 35.6 cc./kg. body weight. The spleen continued to enlarge during the next few months, and the patient was put on feosol, 1 tablet a day, and 6 mg. of testosterone sublingually per day. In October, 1949, he was hospitalized for sharp attacks of hip and shoulder pain with some chest pain which cleared up spontaneously. By December, the red cell count had risen to normal levels again. In November, 1950, the patient had a gastrointestinal hemorrhage which later was diagnosed as a bleeding duodenal ulcer. In April, 1951, he had an episode of thrombophlebitis in his left arm. The spleen continued to remain palpable and his red cell count continued to rise. During this period of time his white cell count, which had been elevated to the 20,000-30,000 range, was now down to the 10,000-15,000 range. From 1941 to June, 1948, the patient was treated by repeated venesections. In July, 1949, it was noted that the patient was becoming anemic, with a ten-



PRIVACY ACT MATERIAL REMOVED

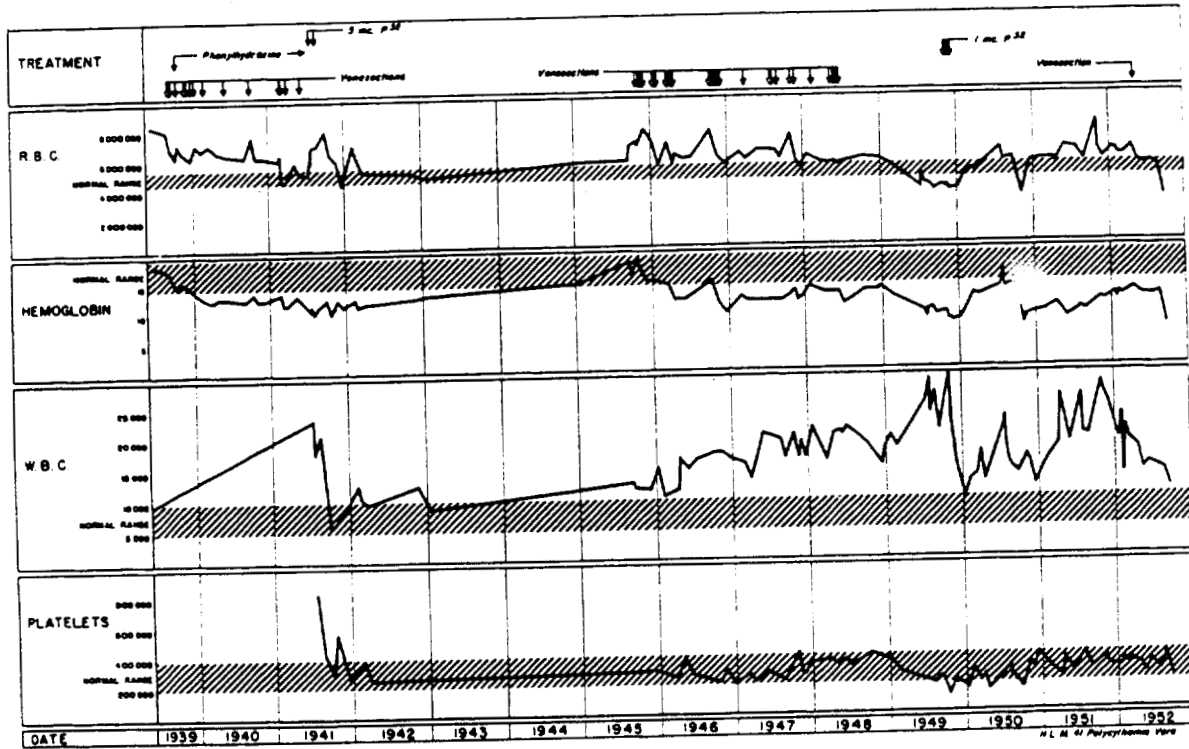

Figure 24: The clinical course of patient

PRIVACY ACT MATERIAL REMOVED

1174566



pounds. After a diagnosis of polycythemia was made by his physician the patient was referred here. During 1947 the patient noticed an increase in the size of a left upper quadrant mass. On physical examination the patient was found to be a thin, dark-skinned man who appeared weak. There was marked injection of the sclerae. The spleen was enlarged filling the entire left upper quadrant and extending into the right lower quadrant. The liver was not palpably enlarged. Blood counts and therapy are shown in Figure 25. While here the patient had a brief episode of broncho-pneumonia which responded satisfactorily to therapy. While under therapy the red cell count, white cell count, hemoglobin, and the platelet count decreased. The size of the spleen decreased markedly so that instead of filling the entire left quadrant, it was palpable only down to the level of the umbilicus and appeared to be much smaller in its lateral diameter. The patient returned in July, 1948, and subsequent therapy was carried out by his referring physician. Beginning in 1950 there was some tendency for a progressive rise in the white cell count with an increase in the number of metamyelocytes, myelocytes, and progranulocytes. The white cell count fell precipitously shortly before death, but there was an increase in the number of immature myeloid cells present. This is an example of a patient who had a satisfactory response to therapy but later developed a picture resembling chronic myelogenous leukemia terminating in a picture morphologically not unlike that of acute myeloblastic leukemia.

#### Patient

This 68 year-old white female was referred here with a diagnosis of polycythemia vera in August, 1949. Her chief complaint was a loss of weight over the preceding five years, with a 30-lb. loss between 1947 and 1949. Since that time her weight has remained more or less stationary in spite of a good appetite and large food intake. During this time the patient has also been "nervous!" In a physical examination in 1947, the spleen was found to be enlarged, but no cause could be found. There had been some occasional substernal burning at night which the patient associated with gas pains and which was relieved by belching.

Physical examination showed the patient to be a very thin woman of average nutrition. The color was described as sallow. Positive findings were: a spleen that was palpable into the pelvis, a liver palpable 4 cm. below the right costal margin. At that time, the blood count was: RBC, 6.48 million; hemoglobin, 18.5 gms.; platelets, 280,000; WBC, 41,000, and reticulocytes, 2.6 percent. The differential was: polymorphonuclears, 64; band cells, 8; metamyelocytes, 2; myelocytes, 3; progranulocytes, 1; myeloblasts, 1; eosinophils, 4; basophils, 5; lymphocytes, 12; and nucleated red cells, 4/100 cc. The sternal marrow puncture was unsatisfactory. Urinalysis showed only an occasional white blood cell per high powered field. Nonprotein nitrogen was 48 mg. percent; bilirubin 1.6 mg. percent; Total protein 7.25; A/G ratio, 1.21/1.00, uric acid was 10 mg.; total cholesterol, 123; and a phenolsulphalein showed 90 percent excreted

PRIVACY ACT MATERIAL REMOVED

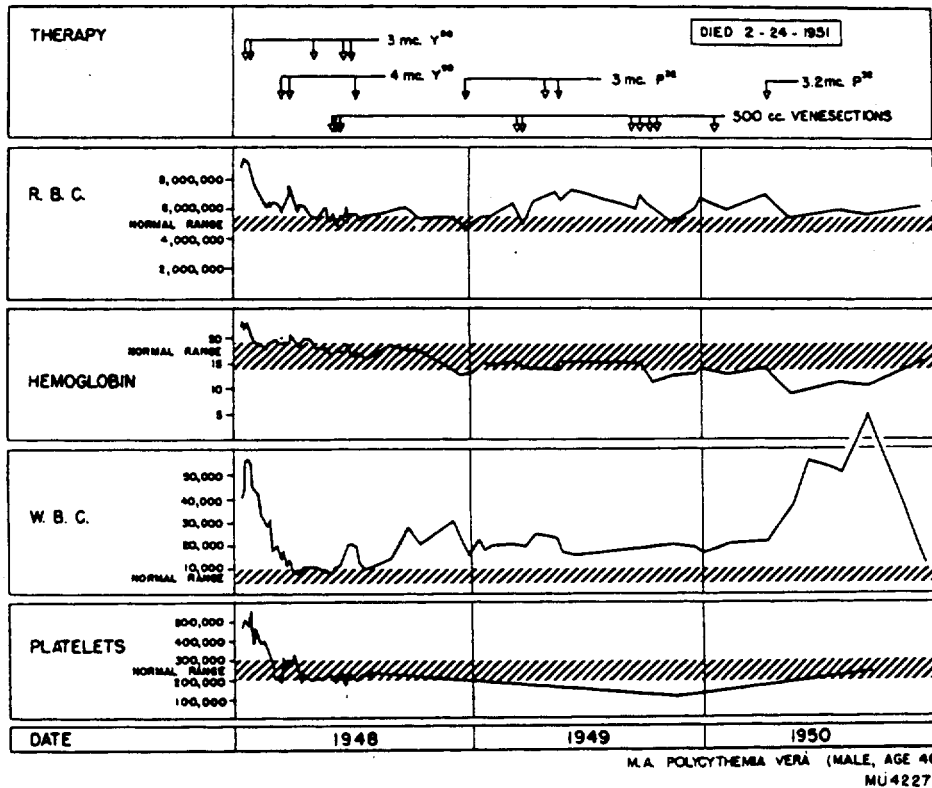

Figure 25: The clinical course of Patient

PRIVACY ACT MATERIAL REMOVED

1174568

in 60 minutes. A second bone marrow puncture showed 65 percent rubricytes, however a cell count was not done so the reliability is difficult to determine. A generalized increase in density of the bone was evident by x-ray, and a bone marrow biopsy showed some increase in fibrous connective tissue. There was but little fat present and a small amount of hematopoietic tissue. The blood volume was 106.8 cc./kg.; total red cell volume, 72.6 cc./kg.; and plasma volume, 33.1 cc./kg. The in vivo iron studies showed production of red cells in the spleen and no evidence of production of red cells in the bone marrow, so this woman definitely has polycythemia. The patient's course and therapy are charted in Figure 26 and Table VI. In 1951 there was a spontaneous decrease in the red cell count and total red cell volume, the former being accentuated by an increase in the plasma volume. Following this there was a rise in the total red cell volume so that by 6-23-52 the patient had a blood volume approximately the same as that determined on her first visit in 1949. Because of the tremendous size of the spleen 25 roentgens were given on 9-3-52, followed by a significant reduction in splenic size.

This is an example of a case of polycythemia vera with red cell formation largely or almost entirely confined to the spleen, and with a hypoplastic bone marrow.

#### Patient

The patient was a 59 year-old white male physician whose chief complaint when first seen here in August, 1949, was fatigue. For the previous five years this patient had noticed tiredness which became especially marked in the two months preceding his first visit here. During this five-year period he also had epigastric distress and headaches. In 1947 diplopia was briefly noted, and lacrimation, burning, and conjunctival injection and irritation were present shortly before he came here. Physical examination revealed elevation of the red cell count and white cell count. A slight ruddy cyanosis of the mucous membranes was noted, there was a small pterygium in the left eye, and a marked bilateral conjunctival injection. The bilateral submaxillary lymph nodes were enlarged. The blood pressure was 160/90, and there was an occasional extra systole. The liver was palpable 6-8 cm. below the costal margin, and the spleen 3 cm. below the costal margin. The initial blood count was: red cells, 7.16 million; 18.5 gms. of hemoglobin; 450,000 platelets; and 23,000 white cells. The sternal marrow puncture was not remarkable. Blood chemistry showed 6.8 mg. percent of uric acid, and the blood oxygen saturation was 96 percent. The hematological course and treatment are detailed in Figure 27. In October, 1949, the patient complained of general lethargy, saying he felt sleepy all the time, and he began to have some numbness over the left side of his face. Neurological examination demonstrated no facial weakness or any cranial nerve involvement. Deep tendon reflexes were equal and active. It was thought on gross visual confrontation that there was defect in the left upper

PRIVACY ACT MATERIAL REMOVED

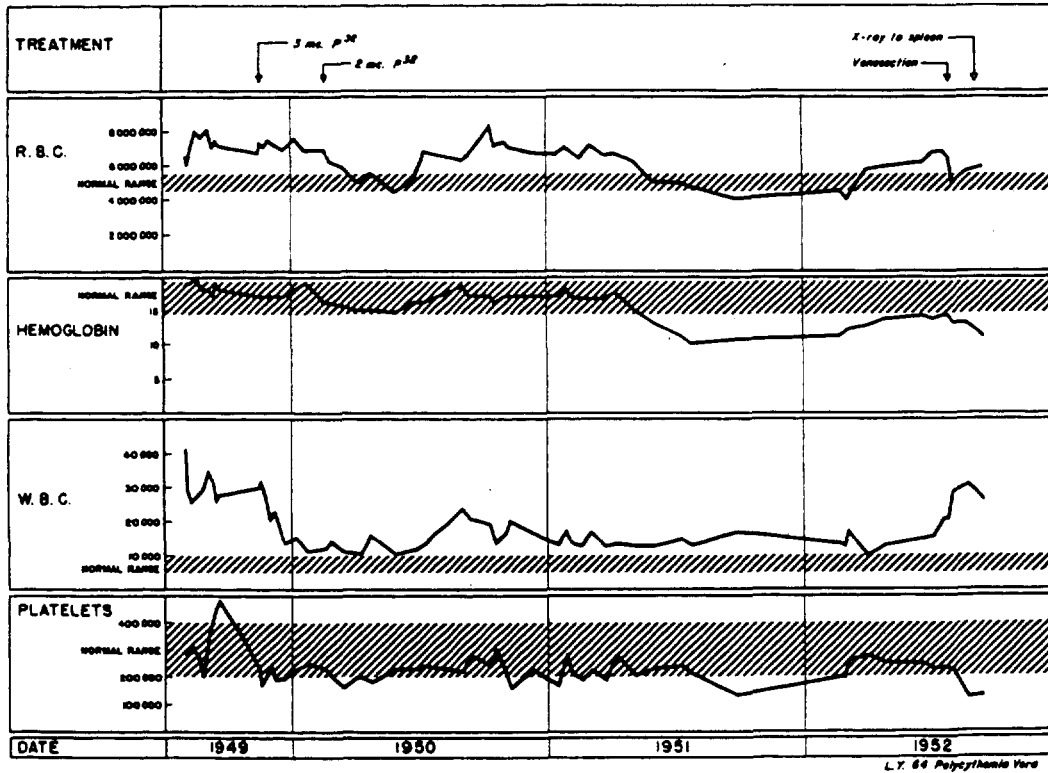

Figure 26: The clinical course of Patient

PRIVACY ACT MATERIAL REMOVED

1174570

PRIVACY ACT MATERIAL REMOVED

TABLE VI

Blood Volume Studies in Patient.

Date	Blood Volume	Total Red Cell Volume	Plasma Volume
3-13-50	100.6	55.3	45.3
10-18-50	86.8	56.5	30.3
7-25-51	96.2	35.1	60.1
3-5-52	97.1	42.2	54.9
6-23-52	99.4	56.9	42.5

PRIVACY ACT MATERIAL REMOVED

1174571

PRIVACY ACT MATERIAL REMOVED

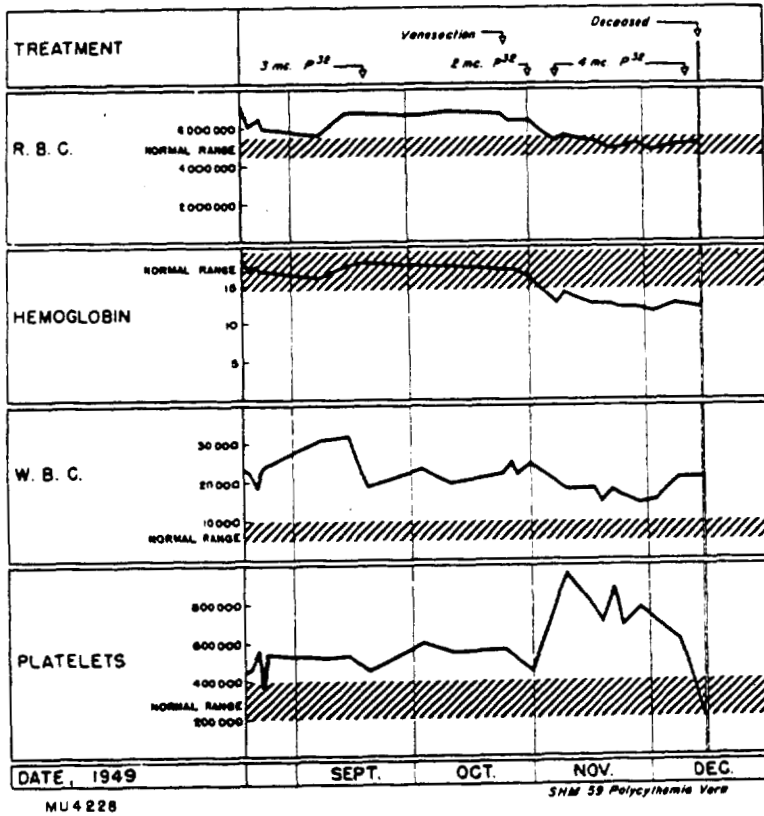

Figure 27: The clinical course of patient

PRIVACY ACT MATERIAL REMOVED

1174572

visual field of both eyes. Shortly thereafter the patient developed evidence of a left hemianesthesia, and a left upper visual field defect. This time it was thought that the patient had a cerebral thrombosis. Optic fundi could not be well visualized, and by November he developed a mild hemiparesis on his left side and a slight left facial weakness. The patient continued to go downhill and expired on December 14, 1949. On autopsy herniation of the right cerebellar tonsil was noted. On gross examination there was an extensive hemorrhagic region centering in the region of the left internal capsule and extending for a distance of approximately 5 cm. The substance of the gray and white matter was filled with punctate hemorrhages and showed considerable degeneration of softening. The involved area included the major portion of the right cerebral hemisphere from a point on a plane with the optic chiasm to the posterior horn of the left ventricle and extended into the cerebral peduncle to occupy the entire right half of the pons. Microscopic examination of this area showed that this mass was a glioblastoma multiforme, and there was considerable hemorrhage in and around the tumor. The ileum and greater trochanter of the femur showed hyperplasia of the bone marrow and the lower part of the femur and the right tibia showed yellow marrow.

This case illustrates the fact that these patients can and do have complications not directly associated with their polycythemia vera.

#### Patient

This patient is a 57 year-old white male first seen in this laboratory on March 7, 1947. In 1936 his wife noticed that his eyes were very red. An examination by his physician showed a reddened tongue and throat and a high red cell count. The patient was then treated with phenylhydrazine but had an unsatisfactory response in that there was too great a decrease in the red cell count. He was then treated by phlebotomy every eight weeks for the next six to seven years. The red cell count was not determined during this interval. In general he has felt quite well with the exception of pruritus.

The initial physical examination revealed a well-built and well-nourished man with a very marked red complexion and a cyanotic appearance over the tip of the nose. The spleen was palpable 4-6 cm. below the costal margin and the liver was palpable 2 cm. below the costal margin. A chest x-ray showed no abnormalities. The initial blood count was: red blood cells, 10.2 million; hemoglobin, 19 gms.; platelets, 220,000; and white blood cells, 18,350. There were no abnormal myeloid cells in the peripheral blood. The patient was treated with eight venesections of approximately 500 cc. each, followed by 3 mc. of P<sup>32</sup>. Subsequent to this therapy the red cell count fell to slightly over 6 million but soon started to rise again and further therapy by repeated venesections and P<sup>32</sup> were given. The spleen decreased in size so that it was no longer palpable. Figure 28 shows that from 1947 until the early part of 1949 the patient had repeated venesections and received a total of 7 mc. of P<sup>32</sup> and 15.8 mc. of Y<sup>90</sup> colloid, which in

PRIVACY ACT MATERIAL REMOVED

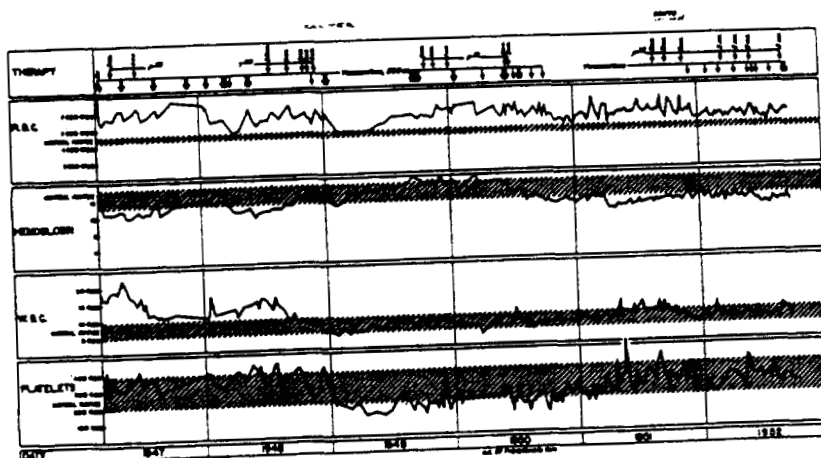

PRIVACY ACT MATERIAL REMOVED

Figure 28: The clinical course of Patient

1174574



its effect is roughly equivalent, millicurie for millicure, to P<sup>32</sup>. Following this the red cell count was brought down into the 5 million range. Later in 1949 the red cell count started to rise and he was again treated with venesections and P<sup>32</sup>. However, it will be noted that the doses of P<sup>32</sup> were much smaller than those given previously because the white cell count, which had been in the 15,000-20,000 range, was now in the 5,000-10,000 range. The platelet count was also in the normal or below normal range. This is typical in many patients in that when they relapse, the white cell count and platelet count do not rise to the level seen previously. Although the patient continued to receive P<sup>32</sup> and venesections throughout 1950-1951, his red cell count continued to be approximately 6 million. As a result of the repeated venesections the hemoglobin stayed in the normal or slightly below normal range so that he is slightly hypochromic. The white cell count and platelet count have remained in the normal range.

This is a case illustrating a very difficult therapeutic problem, since the patient has required very large doses of radiation and repeated phlebotomies to control the red cell count. It should be contrasted to patient who has responded to treatment with much smaller doses at longer intervals.

PRIVACY ACT MATERIAL REMOVED

1174575

BIBLIOGRAPHY

1. Altschule, M. D., Volk, M. C., and Henstell, H., Cardiac and Respiratory Function at Rest in Patients with Uncomplicated Polycythemia Vera, *Am. J. Med. Sc.*, 200: 478, 1940.
2. Berg, W. E., Individual Differences in Respiratory Gas Exchange During Recovery from Moderate Exercise, *Am. J. Physiol.*, 149: 3, 1947.
3. Berk, L., Burchenal, J. H., Wood, T., and Castle, W. B., Oxygen Saturation of Sternal Marrow Blood with Special Reference to Pathogenesis of Polycythemia Vera, *Soc. Exp. Biol. Med.*, 69: 316, 1948.
4. Berlin, N. I., Lawrence, J. H., and Gartland, J., Blood Volume in Polycythemia as Determined by P<sup>32</sup> Labeled Red Blood Cells, *Am. J. Med.*, 9: 747, 1950.
5. Berlin, N. I., Lawrence, J. H., and Lee, H. E., The Life Span of the Red Blood Cell in Chronic Leukemia and Polycythemia, *Science*, 114: 385, 1951.
6. Bishop, L. F., Bishop, L. F., Jr., and Trubek, M., Erythremia, *Ann. Internal Med.*, 8: 12, 1935.
7. Bliss, T. L., Basal Metabolism in Polycythemia Vera, *Ann. Internal Med.*, 2: 1155, 1929.
8. Block, M., and Bethard, W. F., Bone Marrow Studies in Polycythemia, *J. Clin. Invest.*, 31: 618, 1952.
9. Block, M., Jacobson, L., and Bethard, W. F., Personal communication to the authors.
10. Blumgart, H. L., Gargill, S. L., and Gilligan, D. R., Studies on the Velocity of Blood Flow, *J. Clin. Invest.*, 9: 679, 1931.
11. Brooks, W. D. W., Circulatory Adjustments in Polycythemia Rubra Vera, *Proc. Roy. Soc. Med.*, 29: 1379, 1936.
12. Brown, G. E., and Giffin, H. Z., Peripheral Arterial Disease in Polycythemia Vera, *Arch. Internal Med.*, 46: 705, 1930.
13. Brown, G. E., and Giffin, H. Z., Studies on the Vascular Changes in Cases of Polycythemia Vera, *Am. J. Med. Sc.*, 171: 157, 1926.

1174576

14. Brown, G. E., and Sheard, C., Measurements on the Skin Capillaries in Cases of Polycythemia Vera and the Role of These Capillaries in the Production of Erythrosis, *J. Clin. Invest.*, 2: 423, 1926.
15. Buchanan, G., Polycythemia Vera (Erythraemia) Terminating in Myelogenous Leukemia, *S. African Med. J.*, 19: 22, 1945.
16. Carpenter, G., Schwartz, H., and Walker, A. E., Neurogenic Polycythemia, *Ann. Internal Med.*, 19: 470, 1943.
17. Cartwright, G. E., and Wintrobe, M. N., Chemical, Clinical and Immunological Studies on the Products of Human Plasma Fractionation XXXIX. The Anemia of Infection. Studies on the Iron-binding Capacity of Serum, *J. Clin. Invest.*, 28: 86, 1949.
18. Christian, H. A., Nervous Symptoms of Polycythemia Vera, *Am. J. Med. Sc.*, 154: 547, 1917.
19. Erf, L. A., Primary Polycythemia; Remissions Induced by Therapy with Radiophosphorus, 1: 202, 1946.
20. Erf, L. A., and Jones, H. W., Radiophosphorus -- Agent for Satisfactory Treatment of Polycythemia and Its Associated Manifestations; Report of Case of Polycythemia Secondary Possibly to Banti's Syndrome, *Ann. Internal Med.*, 19: 587, 1943.
21. Dameshek, W., Physiopathology and Course of Polycythemia Vera as Related to Therapy, *J. Am. Med. Assoc.*, 142: 790, 1950.
22. Dameshek, W., and Henstell, H. H., Diagnosis of Polycythemia, *Ann. Internal Medicine*, 13: 1360, 1940.
23. Dameshek, W., and Henstell, H. H., The Treatment of Polycythemia Vera by the Production of a Chronic Iron Deficiency State, *J. Clin. Invest.*, 16: 683, 1937.
24. Finch, S., Haskins, D. M., and Finch, C., Iron Metabolism. Hematopoiesis Following Phlebotomy. Iron as a Limiting Factor, *J. Clin. Invest.*, 8: 1, 1950.
25. Forsell, J., Polycythemia in Hypernephroma, *Nord. Med.*, 30: 1415, 1946.
26. Gaisbock, F., Die Polycythamien, *Ergeb. inn. Med. u Kinderheilk*, 21: 234, 1922.
27. Garcia, J. F. Unpublished data.

1174577

J. 5. 1951

28. Giffin, H. Z., and Allen, E. V., The Control and Complete Remission of Polycythemia Vera Following the Prolonged Administration of Phenylhydrazine Hydrochloride, *Am. J. Med. Sc.*, 185: 1, 1933.
29. Giffin, H. Z., and Conner, H. M., The Untoward Effects of Treatment by Phenylhydrazine Hydrochloride, *J. Am. Med. Assoc.*, 92: 1505, 1929.
30. Glaessner, K., Beitrag zur Pathologie der Polyzythaemia rubra, *Wien. klin. Woch. schr.*, 49: 1475, 1906.
31. Goetsch, A. T., and Lawrence, J. H., Familial Occurrence of Polycythemia and Leukemia, *Calif. Med.* 73: 361, 1950.
32. Graham, D., Erythraemia - Polycythemia Rubra Vera, *Can. Med. Assoc. J.*, 42: 281, 1940.
33. Haden, R. L., The Red Cell Mass in Polycythemia in Relation to Diagnosis and Treatment, *Am. J. Med. Sc.*, 196: 493, 1938.
34. Hall, B. E., Therapeutic Use of Radiophosphorus in Polycythemia Vera, Leukemia, and Allied Diseases, in the Use of Isotopes in Biology and Medicine, Madison, Wis., University of Wisconsin Press, 1948, p. 353.
35. Hamilton, A. L., and Morse, M. E., A Study of Erythrocythemia and Report of a Case, with Autopsy, *Boston Med. Surg. J.*, 166: 963, 1912.
36. Hansen-Pruss, E. C., and Goodman, E. G., Acute Leukemia as a Terminal Event in Polycythemia Vera: Report of Two Cases with Autopsies, *N. Carolina Med. J.*, 4: 7, 1943.
37. Hardgrove, M., Yunk, R., Zotter, H., and Murphy, F., A Summary of Eight Living Cases of Pernicious Anemia, *Ann. Internal Med.*, 20: 806, 1944.
38. Harrop, G. A., Jr., Polycythemia, *Medicine*, 7: 291, 1928.
39. Harrop, G. A., Jr., and Heath, E. H., Pulmonary Gas Diffusion in Polycythemia Vera, *J. Clin. Invest.*, 4: 53, 1927.
40. Haynal, E., and Graf, F., The Role of the Hypophyseal-Hypothalamic System in the Pathology of Erythraemia and Symptomatic Polycythaemias, *Acta Med. Scand.*, 139: 62, 1950.
41. Herzog, F., and Kleiner, G., Ergebnis der Diätbehandlung in 19 Fällen von Polyzythämie, *Deut. Med. Woch. schr.*, 65: 719, 1939.

1174578

42. Hines, L. E., and Darnall, W. C., The Control of Polycythemia by Venesection, *Am. J. Med. Sc.*, 206: 434, 1943.
43. Hirsch, F., Generalized Osteosclerosis with Chronic Polycythemia Vera, *Arch. Path.*, 19: 91, 1935.
44. Holmber, C. G., and Laurell, C. B., Studies on the Capacity of Serum to Bind Iron, *Acta Physiol. Scand.*, 10: 307, 1945.
45. Huff, R. L., Elmlinger, P. J., Garcia, J. F., Cockrell, M. C., and Lawrence, J. H., Ferrokinetics in Normal Persons and in Patients Having Various Erythropoietic Disorders, *J. Clin. Invest.*, 30: 1512, 1951.
46. Huff, R. L., Hennessy, T. G., Austin, R. E., Garcia, J. F., Roberts, B. M., and Lawrence, J. H., Plasma and Red Cell Turnover in Normal Subjects and in Patients Having Various Hematopoietic Disorders. *J. Clin. Invest.*, 29: 1041, 1950.
47. Huff, R. L., Lawrence, J. H., Siri, W. E., Wasserman, L. R., and Hennessy, T. G., Effect of Changes in Altitude on Hematopoietic Activity, *Medicine*, 30: 197, 1951.
48. Hurtado, A., Merino, C. and Delgado, E., Influence of Anoxemia on the Hematopoietic Activity, *Arch. Internal Medicine*, 75: 284, 1945.
49. Hutchinson, R., and Miller, C. H., A Case of Splenomegalic Polycythaemia, with Report of Post-Mortem Examination, *Lancet*, 1: 744, 1906.
50. Issacs, R., Pathologic Physiology of Polycythemia Vera, *Arch. Internal Med.* 31: 289, 1923.
51. Jones, H. B., Respiratory System: Nitrogen Elimination. In Otto Glasser (ed.), *Medical Physics*, Vol. 2. Chicago, Yearbook Publishers, 1950.
52. Joslin, E. P., Krall, L. P., Bailey, C. C., Rost, H. F., White, P., and Marble, A., *Medical Progress: Diabetes*, *New Eng. J. Med.*, 238: 437, 1948.
53. Kennedy, A. M., Untoward Effect of Phenylhydrazine Hydrochloride in Polycythemia, *Brit. Med. J.*, 1: 659, 1934.
54. Klumpp, T. G., and Hertig, A. T., Erythremia and Myelogenous Leukemia, *Am. J. Med. Sc.*, 183: 201, 1932.
55. Lasch, F., Uber die Behandlung der Polyglobulie mit eiweissarmer Kost, *Med. Klin.*, 36: 615, 1938.

1174579

335701

56. Laurell, C. B., Studies on the Transportation and Metabolism of Iron in the Body, with Special Reference to the Iron-Binding Component in Human Plasma, *Acta Physiol. Scand.*, Supp. 14, 46, 1947.
57. Lawrence, J. H., Some Tracer and Therapeutic Studies with Artificial Radioactivity, *Brit. J. Radiology*, 21: 531, 1948.
58. Lawrence, J. H., The Control of Polycythemia by Marrow Inhibition, *Am. J. Med.*, 141: 13, 1949.
59. Lawrence, J. H., and Berlin, N. I., Relative Polycythemia - the Polycythemia of Stress, *Yale J. Biol. Med.*, 24: 498, 1952.
60. Lawrence, J. H., Dobson, R. L., Low-Beer, B. V. A., and Brown, B. R., Chronic Myelogenous Leukemia: A Study of 129 Cases in Which Treatment was with Radioactive Phosphorus, *J. Am. Med. Assoc.*, 136: 672, 1948.
61. Lawrence, J. H., Elmlinger, P. J., and Fulton, G., Oxygen and the Control of Red Cell Production in Primary and Secondary Polycythemia: Effects on the Iron Turnover Patterns with Fe<sup>59</sup> as Tracer, *Card.* (In press.)
62. Lawrence, J. H., Huff, R. L., Siri, W. E., Wasserman, L. R., and Hennessy, T. G., A Physiological Study in the Peruvian Andes, *Acta Med. Scand.*, 142: 117, 1952.
63. Lawrence, J. H., and Rosenthal, R. L., Multiple Myeloma Associated with Polycythemia, *Am. J. Med. Sc.*, 218: 149, 1949.
64. Lee, R. I., A Case of Polycythemia Vera or Erythremia, *Med. Clinics N. Amer.*, 21: 369, 1937.
65. Loew, J., and Popper, H., Beitrag zur Klinik der Polyzythamie, *Wien. klin. Woch. schr.*, 21: 357, 1908.
66. London, I. M., Shemin, D., West, R., and Rittenberg, D., Heme Synthesis and Red Blood Cell Dynamics in Normal Humans and in Subjects with Polycythemia Vera, Sickle-Cell Anemia, and Pernicious Anemia, *J. Biol. Chem.*, 179: 463, 1949.
67. Luce, Ueber Erythrozytosen und ihre Pathogenese, *Med. Klin.*, 5: 122, 1909.
68. Ludeke, H., Thrombophilie und Polycythamie, *Virchows Arch. path. Anat.*, 293: 218, 1934.
69. McAlpin, K. R., A Case of Polycythemia Rubra Vera with Leukemia Blood Picture, *J. Am. Med. Assoc.*, 92: 1825, 1929.

1174580

70. Manning, I. H., The Diagnostic Value of the Sternal Bone Marrow Puncture in Polycythemia Vera., Am. J. Med. Sc., 214: 469, 1947.
71. Merino, C. F., and Reynafarje, C., Bone Marrow Studies in the Polycythemia of High Altitudes, J. Lab. Clin. Med., 34: 637, 1949.
72. Miller, H. R., The Occurrence of Coronary Artery Thrombosis in Polycythemia Vera, Am. J. Med. Sc., 198: 323, 1939.
73. Minot, G. R., and Buckman, T. E., Erythremia, Am. J. Med. Sc., 166: 469, 1923.
74. Miranda, A., Personal communication to the authors.
75. Moehlig, R. C., and Bates, G. S., Influence of the Pituitary Gland on Erythrocyte Formation, Bull. Johns Hopkins Hosp., 50: 137, 1932.
76. Moewes, C., Ueber Polycythaemia rubra, Deut. Arch. Klin. Med., 111: 281, 1913.
77. Morris, R. S., Anerythremic-erythremia, Bull. Johns Hopkins Hosp., 21: 37, 1910.
78. Norman, I. L., and Allen, E. V., The Vascular Complications of Polycythemia, Am. Heart J., 13: 257, 1937.
79. Oppenheimer, B. S., Thrombosis in Polycythemia Vera, Trans. Assoc. Am. Physicians, 44: 338, 1929.
80. Osler, W., Chronic Cyanosis with Polycythemia and Enlarged Spleen, A New Clinical Entity, Am. J. Med. Sc., 126: 187, 1903.
81. Pierce, F. and Gofman, J. W., Unpublished observations.
82. Prentice, T. C., Berlin, N. I., and Lawrence, J. H., Effect of Therapy on Blood Volume, Blood Pressure, and Spleen Size in Polycythemia Vera, Arch. Internal Med., 89: 584, 1952.
83. Rath, C. E., and Finch, C. A., Chemical, Clinical and Immunological Studies on the Products of Human Plasma Fractionation. XXXVIII. Serum Iron Transport, Measurement of Iron-binding Capacity of Serum in Man, J. Clin. Invest., 28: 79, 1949.
84. Reznikoff, P., Fost, N. C., and Bethea, J. M., Etiologic and Pathologic Factors in Polycythemia Vera, Am. J. Med. Sc., 189: 753, 1935.
85. Ribbert, H., Ueber das Myelom, Zbl. Allg. Path. path. Anat., 15: 337, 1904.

1174581

1000000

86. Richardson, W., and Robbins, L. L., The Treatment of Polycythemia Vera by Spray Irradiation, *New Eng. J. Med.*, 238: 78, 1948.
87. Robertson, J. S., Siri, W. E., and Jones, H. B., Lung Ventilation Patterns Determined by Analysis of Nitrogen Elimination Rates, Use of Mass Spectrometer as a Continuous Gas Analyzer, *J. Clin. Invest.*, 29: 577, 1950.
88. Rosengart, J., Milztumor und Hyperglobulie, *Mitt. Grena. Med. Chir.*, 11: 495, 1903.
89. Rosenthal, N., and Bassen, F. A., Course of Polycythemia, *Arch. Internal Med.*, 62: 903, 1938.
90. Rosenthal, N., and Erf, L. A., Clinical Observations on Osteopetrosis and Myelofibrosis, *Arch. Internal Med.*, 71: 793, 1943.
91. Rosenthal, R. L., Blood Coagulation in Polycythemia and Leukemia: Value of the Heparin Clotting Time and Clot Retraction Rate, *J. Lab. Clin. Med.* 34: 1321, 1949.
92. Rosenthal, R. L., and Tobias, C. W., Measurement of the Electric Resistance of Human Blood; Use in Coagulation Studies and Cell Volume Determinations, *J. Lab. Clin. Med.*, 33: 1110, 1948.
93. Schade, A. L., and Caroline, L., An Iron-binding Component in Human Blood Plasma, *Science*, 104: 340, 1946.
94. Schade, A. L., and Caroline, L., Raw Hen Egg White and the Role of Iron in Growth Inhibition of Shigella dysenteriae, Staphylococcus aureus, Escherichia coli, and Saccharomyces cerevisiae, *Science*, 100: 14, 1944.
95. Schafer, P. W., The Etiology and Treatment of Polycythemia Rubra Vera. Observations Based upon Studies of Body Fluid Changes in Dogs Subjected to Proprioceptor Depressor Neurotomy and Extensive Sympathectomy, Including a Case Report of a Man with Polycythemia Rubra Vera Treated by Extensive Paravertebral Sympathectomy, *Ann. Surg.* 122: 1098, 1945.
96. Schneider, P., Sektionsbefund bei Polyzythamie, *Munch. med. Wochschr.* 65: 689, 1918.
97. Schulhof, K. and Matthies, M. M., Polyglobulia Induced by Cerebral Lesions, *J. Am. Med. Assoc.*, 89: 2093, 1927.
98. Schwartz, B. M., and Stats, D., Oxygen Saturation of Sternal Marrow Blood in Polycythemia Vera, *J. Clin. Invest.*, 28: 736, 1949.
99. Shelburne, S. A., and Hanzal, R. B., The Endogenous Uric Acid Metabolism in Polycythemia Vera, *J. Clin. Invest.*, 11: 865, 1932.

1174582



100. Smith, R. P., and Silberberg, M., Multiple Myeloma of Hemocytoblastic Type, Arch. Path., 21: 578, 1936.
101. Spurr, C. L., Smith, T. R., Block, M. H., and Jacobson, L. O., Clinical Study of the Use of Nitrogen Mustard in Polycythemia Vera, J. Lab. Clin. Med., 35: 252, 1950.
102. Stealy, C. L., and Summerlin, H. S., Polycythemia Vera: Final Report on Case Under Continual Treatment with Phenylhydrazine Hydrochloride for 11 Years, J. Am. Med. Assoc., 126: 954, 1944.
103. Stephens, D. J., and Kaltreider, N. L., The Therapeutic Use of Venesection in Polycythemia, Ann. Internal Med., 10: 1565, 1937.
104. Sternberg, C., Polycythamie, In F. Henke, and O. Lubarsch, Handbuch der speciellen pathologischen Anatomie Histologie, Berlin, Springer, 1926, p. 27.
105. Stover, L., and Herrell, W. E., Extensive Thrombosis of the Right Subclavian and Axillary Veins Associated with Thrombophlebitis, Lymphadema and Polycythemia Vera, Proc. Staff Meetings, Mayo Clinic, 15: 817, 1940.
106. Stroebel, C. F., Hall, B. E., and Pease, G. L., Evaluation of Radiophosphorus Therapy in Primary Polycythemia, J. Am. Med. Assoc., 146: 1301, 1951.
107. Surgenor, D. M., Koechlin, B. A., and Strong, L. C., Chemical, Clinical and Immunological Studies on the Products of Human Plasma Fractionation. XXXVII. The Metal-combining Globulin of Human Plasma., J. Clin. Invest., 28: 73, 1949.
108. Talbott, J. H., Studies at High Altitudes II: Morphology and Oxygen Combining Capacity of the Blood, Folia Haematol., 55: 23, 1936.
109. Taylor, C. E., Erythroid Multiple Myeloma, Am. J. Clin. Path., 17: 222, 1947.
110. Tinney, W. S., Hall, B. E., and Giffin, H. Z., Cardiac Disease and Hypertension in Polycythemia Vera, Proc. Staff Meetings, Mayo Clinic, 18: 94, 1943.
111. Tinney, W. S., Hall, B. E., and Giffin, H. Z., Central Nervous System Manifestations of Polycythemia Vera, Proc. Staff Meetings, Mayo Clinic, 18: 300, 1943.
112. Tinney, W. S., Hall, B. E., and Giffin, H. Z., Hematologic Complications of Polycythemia Vera, Proc. Staff Meetings, Mayo Clinic, 18: 227, 1943.

1174583

113. Tinney, W. S., Hall, B. E., and Giffin, H. Z., Polycythemia Vera and Peptic Ulcer, Proc. Staff Meetings, Mayo Clinic, 18: 24, 1943.
114. Tinney, W. S., Hall, B. E., and Giffin, H. Z., The Prognosis of Polycythemia Vera, Proc. Staff Meetings, Mayo Clinic, 20: 306, 1945.
115. Tinney, W. S., Hall, B. E., and Giffin, H. Z., The Liver and Spleen in Polycythemia Vera, Proc. Staff Meetings, Mayo Clinic, 18: 46, 1943.
116. Tinney, W. S., Polley, H. F., Hall, B. E., and Giffin, H. Z., Polycythemia Vera and Gout, Proc. Staff Meetings, Mayo Clinic, 20: 49, 1945.
117. Tinsley, J. C., Jr., Moore, C. V., Dubach, R., Minnich, V., and Grinstein, M., The Role of Oxygen in the Regulation of Erythropoiesis, J. Clin. Invest., 28: 1544, 1949.
118. Tischendorf, W., and Herzog, K., Mehrjarige Beobachtungen uber chronische Leukamien and Polycythamien, Deut. Arch. klin. Medi., 185: 566, 1940.
119. U. S. Bureau of the Census, Mortality Statistics, 1940 -44. Government Printing Office, 1945.
120. Vaquez, M. H., Concerning a Special Form of Cyanosis with Accompanying Excessive and Persistent Hyperglobulia, Compt. rend. Soc. biol., 44: 384, 1892.
121. Videbaek, A., Polycythemia Vera - Course and Prognosis, Acta Med. Scand., 138: 3, 1950.
122. Wasserman, L. R., Dobson, R. L., and Lawrence, J. H., Blood Oxygen Studies in Patients with Polycythemia and in Normal Subjects, J. Clin. Invest., 28: 60, 1949.
123. Wasserman, L. R., Lawrence, J. H., Berlin, N. I., Dobson, R. L., and Estren, S., The Bone Marrow Picture in Polycythemia Vera Before and After Treatment with Radioactive Phosphorus, Acta Med. Scand. (In press.)
124. Watson-Wemyss, H. L., A Case of Vaquez's Disease: Polycythemia with Plethora and Splenomegaly, Brit. Med. J., 1: 702, 1913.
125. Weber, F. Parkes, A Case of Erythraemia with Jaundice, Hepatic Cirrhosis, and Haematemesis, and Remarks on Erythraemia and Erythroleukaemia, Lancet, 224: 800, 1933.

126. Weber, F. Parkes, and Watson, J. H., Chronic Polycythemia with Enlarged Spleen, Probably a Disease of the Bone Marrow, Brit. Med. J., 1: 729, 1904.
127. von Winterfeld, H. K., Uber die Kombination der Polycythamia rubra mit leukamischen Myelose, Z. klin. Med., 100: 498, 1924.
128. Zadek, I., Die Polycythamien, Ergeb. d Ges. Med., 10: 355, 1927.

1174585

000000

## II. THE METABOLIC PROPERTIES OF VARIOUS MATERIALS

Joseph G. Hamilton, M. D.

Project 48A

### TRACER STUDIES

#### Versene Studies with Plutonium

J. G. Hamilton and K. G. Scott

The major effort of the tracer program for the past quarter has been devoted to a continuation of experiments involving attempts to remove plutonium from rats by the use of the calcium salt of Versene.

A preliminary report was made in August but was not included in this quarterly report since it was necessary for it to be declassified due to the fact that an analytical technique employing TTA was used. The data is now being recomputed to obtain the mean standard error. The material obtained from this data will be given in the next quarterly report. During this quarter an experiment was organized in which 2 groups of 10 rats were employed. All of the animals received plutonium<sup>238</sup> in the +6 valence state by intravenous administration. The animals were maintained in suitable metabolism cages for adequate collection of both urine and feces.

Twenty-five days after plutonium was given, 10 of the animals received the calcium salt of Versene by intraperitoneal injection at a dose level of approximately 600 mg/kilo of body weight. The animals were sacrificed and the following tissues, organs and body fluids were obtained: spleen, blood, liver, kidneys, gastro-intestinal tract and contents, skeleton, muscle, skin and the tissue described as balance, which was the eviscerated carcass of the animals. From this value there was subtracted the calculated values for muscle, blood and skeleton.

The data indicated the effect of Versene on the urinary and fecal excretion as shown in Table I. A definite increase in the urinary excretion is to be observed. There was a slight increase in the fecal excretion of plutonium but it would appear to be too small to be significant.

The plutonium content of the organs, tissues and body fluids shown in Table II indicates that, with the exception of blood and the kidney, the values were significantly lower in plutonium content in the treated animals. The skeletons of the treated animals were on the average 12 percent lower than for the controls. Because of the relatively large number

1174586

TABLE I

THE DAILY EXCRETION RATES OF  $\text{Pu}^{238}$  OF CONTROL AND "VERSENE"-TREATED RATS. TREATED ANIMALS RECEIVED AN AVERAGE OF 162 MGM. OF "VERSENE" PER DAY BEGINNING THE 25TH DAY.

	URINE		FECES	
	Treated	Control	Treated	Control
	Percent of administered $\text{Pu}^{238}$ excreted.			
0-1	2.69	2.98	2.09	1.50
1-3	0.29	0.21	1.02	0.81
3-6	0.18	0.12	0.83	0.87
6-10	0.097	0.11	0.67	0.72
10-13	0.089	0.097	0.80	0.72
13-17	0.083	0.073	0.35	0.37
17-20	0.070	0.061	0.40	0.38
20-24	0.064	0.076	0.42	0.41
	CaEdta		CaEdta	
24-27	0.70	0.049	0.47	0.34
27-31	0.53	0.043	0.42	0.12
31-34	0.45	0.040	0.44	0.28
34-38	0.25	0.037	0.25	0.13
38-41	0.38	0.036	0.24	0.18
41-45	0.26	0.037	0.19	0.16
45-48	0.26	0.028	0.18	0.12
48-49	0.14	0.024	0.35	0.21
Total Excreted:	15.0	6.2	23.7	19.2

1174587

287011

TABLE II

THE EFFECT OF "VERSENE" UPON THE DISTRIBUTION OF Pu<sup>238</sup> IN RATS. TREATMENT WAS BEGUN 25 DAYS AFTER THE I. V. ADMINISTRATION OF THE Pu<sup>238</sup>. THE RATS RECEIVED AN AVERAGE OF 162 MG. OF "VERSENE" PER DAY FOR 25 DAYS AND A TOTAL OF 3.9 GRAMS. THE DATA ARE CORRECTED FOR RECOVERY AND ARE EXPRESSED AS PERCENT OF THE DOSE PRESENT PER ORGAN AND GRAM OF TISSUE. THE VALUES SHOWN ARE THE AVERAGES FOR THE 10 RATS IN EACH GROUP.

TISSUE	CONTROL			"VERSENE"			
	Percent per organ	Mean Std. deviation	Percent per gram	Mean Std. deviation	Percent per organ	Percent per gram	Mean Std. deviation
Spleen	0.917	±0.051	1.63	±0.13	0.448	0.665	±0.070
Blood	0.157	0.012	0.011	0.0002	0.139	0.010	0.011
Liver	5.32	0.33	0.639	0.060	5.07	0.481	0.51
Kidneys	0.679	0.067	0.374	0.046	0.647	0.318	0.031
G.I. Tract	0.284	0.041	-	-	0.158	-	0.023
Skeleton	61.37	1.02	3.10	0.07	52.0	2.72	1.08
Muscle	1.07	0.18	0.011	0.002	0.808	0.009	0.081
Skin	0.978	0.044	0.028	0.002	0.531	0.020	0.12
Balance	3.69	0.12	-	-	1.48	-	0.20
Urine	6.24	0.54	-	-	15.0	-	0.90
Feces	19.26	1.46	-	-	23.72	-	1.57
Actual Recovery:			82.34 Percent				90.0 Percent
Average Body Wt.			235 grams				216 grams

of animals in both groups this difference is considered significant and a statistical evaluation of the data gives a P value of less than 0.01. The amount of Versene administered as a calcium salt was of sufficient magnitude that some of the treated animals lost weight and appeared in a rather poor physical condition. From these data as well as other data to be given in the next quarterly report, it would seem that in the rat such treatment produces a relatively small effect when nearly lethal amounts of this chelating agent are administered.

Currently there has been set up a series of studies to determine the degree of possible removal of curium in rats by the use of the calcium salt of Versene. Upon theoretical grounds it possibly may be that curium might be more readily chelated in the animal body than plutonium, though of course, this must remain speculative until the actual data is available.

1174589

078-111

Metabolism of Radio-Fluorine in the Rat

Patricia Wallace

Production and Standardization of F<sup>18</sup>

The fluorine isotope used in this series of experiments was F<sup>18</sup> which is radioactive with a half-life of 112 minutes (Snell<sup>1</sup>) and emits positrons with a maximum energy of 0.64 Mev (Blaser, et al.<sup>2</sup>). Radio-fluorine is produced by the bombardment of fractionally distilled water from the Cutter Laboratories with 28 Mev alpha particles on the 60-inch cyclotron at the Crocker Laboratory by the reaction  $O^{16}(\alpha, pn)F^{18}$ . The yield from this reaction averages 750 microcuries per microampere-hour bombardment. \*

Water is a particularly useful target material, because it is easy to handle and there are no other activities induced by alpha particle bombardment with half-lives of more than a few minutes. The target water is contained in a small all-glass cell with a thin window (less than 100 mgm/cm<sup>2</sup>) cooled by a stream of cold air blown onto the back of the chamber and fitted with a water-jacket condenser. The cyclotron beam intensity was monitored by passing a copper wire through the condenser into the target cell and measuring the current in the water. Figure 1 shows the target cell and cyclotron window assembly set up for bombardment.

After a brief interval to allow the short-lived activities produced to decay away, the target material was transferred to a beaker, a few milligrams of NaOH were added, and the solution was evaporated to the desired volume. After cooling, sufficient HCL was added to bring the solution to pH7. The amounts of HCL and NaOH added were such that the final solution was isotonic. In the cases where stable fluoride was added to the injected material, NaF was added to the target water prior to evaporation in amounts such that the final solution was isotonic NaF.

The half-life of all radio-fluorine preparations was checked with a decay curve run for at least 8 hours and in some cases for 24 hours. At no time was there evidence of the presence of any long-lived contaminants. The positron energy was determined by mass absorption in aluminum and was in agreement with the value published in the literature, (Blaser, et al.<sup>2</sup>). The activity of all samples was measured by taking advantage of the 0.5 Mev photons associated with the annihilation of the positrons. All tissue samples were placed in tin bottle caps and counted wet with a scintillating sodium iodide crystal gamma counter as described by Jenkins<sup>3</sup>. The sensitivity of

---

\* (One microampere-hour of alpha particles equals  $3 \times 10^{12}$  incident particles per second for one hour).

1174590



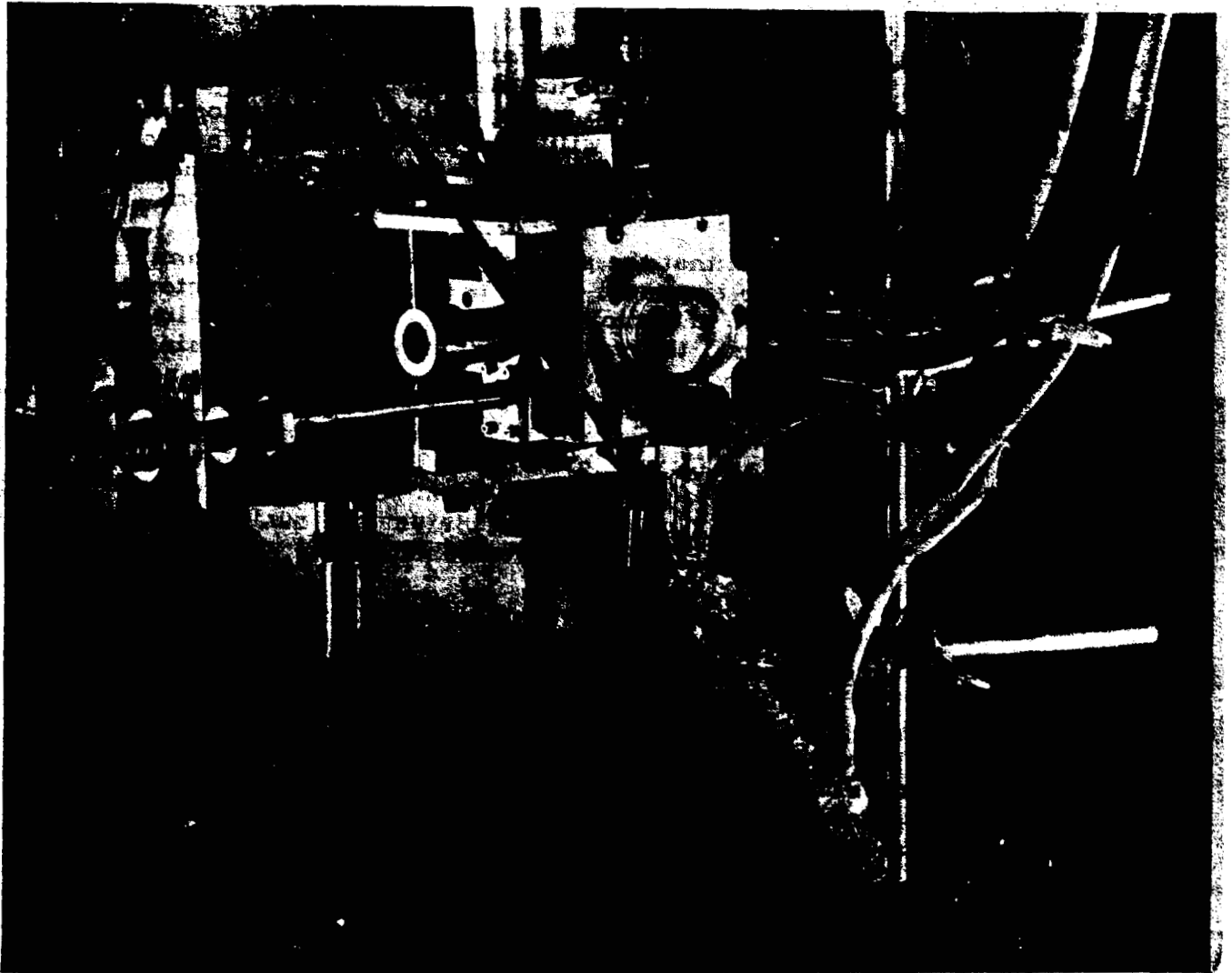

ZN-482

Figure 1: Target cell and cyclotron window assembly for production of carrier-free radio-fluorine.

1174591

278 111

this instrument for 0.5 Mev annihilation radiation when the radioactive sample is 4 cm. from the crystal is such that 2000 c/s represents one microcurie of radio-fluorine.

### Materials and Methods

The animals used were females of the Long-Evans strain ranging in body weight from 150 to 230 grams which corresponds to an age of from about 9 to 16 weeks.

The animals were fed a laboratory chow equivalent to the "Diet 14" of the Institute of Experimental Biology (University of California, Berkeley) and had free access to tap water. The concentration of fluorine in the feed is to be determined and will be reported later. The Berkeley water supply was analyzed for the fluorine on June 1, 1952 by the East Bay Municipal Utility District and was found to be less than 0.03 ppm.

It will be noted that the amount of radio-fluorine administered varied greatly from group to group. This is due to several factors. Because of the short half-life of radio-fluorine and the relatively low sensitivity of the gamma counter, the radio-fluorine produced in a single bombardment was used for only one group of 5 animals. Several target cells were used in the course of the experiments. The windows of these cells were variable in thickness, the thicker ones giving a poorer yield. In order to avoid thermal damage and breakage of the thin windows of the target cells during bombardment, the cyclotron beam intensity was limited from 4 to 8 microamperes. On several occasions the cyclotron beam intensity was much lower than the above mentioned limits, decreasing the yields still further.

The animals received from 250 to 500 microcuries of radio-fluorine. The larger amount is quite adequate for a complete tracer study up to 9 hours. If 500 microcuries is given to a rat weighing 150 grams and the animal is sacrificed 9 hours later, the rat will receive a total body radiation dose of approximately 5 r. e. p., assuming that radio-fluorine is evenly distributed throughout the body and that none of it is excreted during this interval. Considering the fact that the skeleton, which is approximately 10 percent of the body weight accumulates 50 percent of the administered radio-fluorine, the radiation dose to the skeleton would be approximately 25 r. e. p., if the energy absorbed per cc. of bone is greater than that for soft tissue (93 ergs. absorbed per cc. of soft tissue equals 1 r. e. p.), and consequently the radiation dose to the skeleton due to the positrons emitted by radio-fluorine may be considerable. Since the percent uptake of radio-fluorine by the skeleton did not vary significantly with large doses there would appear to be little if any radiation effect during the time interval of these studies. In the case where a dose of 500 microcuries of radio-fluorine was administered orally, it might be assumed that the radiation dose to the

1174592

gastric and intestinal mucosa during the first few minutes after administration is large enough to be significant. However, since absorption from the gut proceeded rapidly, 75 percent in the first hour and 87 percent at the end of 4 hours, it would seem that the absorptive processes of the G. I. tract were not materially impaired by radiation damage.

Carrier-free radio-fluorine was given intravenously via the external jugular vein to 3 groups of 5 rats which were sacrificed 15 minutes, 1 and 4 hours after injection and to 2 groups of 3 rats which were sacrificed at 9 hours. This lot of 21 animals was used for tracer studies, the results of which are shown in Table I. In order to obtain a complete picture of the disappearance of radio-fluorine from the blood, 6 groups of 5 rats were given carrier-free radio-fluorine intravenously and sacrificed 1, 5, 20, 30, 45 and 60 minutes after injection. Blood samples were taken from this lot of 30 animals. The decrease in the radio-fluorine concentration of the blood with time is shown in Figure 2 which also includes the blood values of the 2 early time groups of the above mentioned tracer studies. Radio-fluorine was administered to 8 rats intravenously with 10 mg/kilo of stable fluorine as NaF. Five of these animals were sacrificed 15 minutes after injection and the other 3, 9 hours after injection. The data obtained from these 2 groups of animals is given in Table II. Fifteen rats were given 2 cc. of carrier-free radio-fluorine solution orally by stomach tube followed by 1 cc. of saline wash. These animals were sacrificed in groups of 5, at intervals of 1, 4, and 9 hours after administration of radio-fluorine. The distribution of orally administered carrier-free radio-fluorine is shown in Table III. Ether was the anesthetic used in all cases. Prior to oral administration the animals were fasted for 12 hours. After administration of radio-fluorine all experimental animals were placed in metabolism cages for the collection of excreta. After injection, animals were given water but no food.

The animals were sacrificed with chloroform and blood samples were withdrawn by heart puncture. They were then skinned and the following organs and tissues taken: liver, kidney, stomach, stomach contents, small intestine, small intestine contents, large intestine, large intestine contents, cecum, muscle and bone from the right hind leg, cartilage from the xiphoid process, one-fourth of the pelt, heart, lungs, spleen, pancreas, cervical lymph nodes, parotid, and submaxillary glands, adrenals, thyroid and lacrimal glands. Small tissues which included salivary glands, lacrimal glands, lymph nodes, thyroid, adrenals, pancreas and cartilage were pooled. The skinned eviscerated carcass was ground in a meat grinder and divided into several portions for assay.

During the assay of the samples, a standard quantity of radio-fluorine was counted hourly and corrections made for decay.

Values in the tables are expressed as percent of administered dose per gram of wet tissue and as percent of dose per whole organ. All samples were counted until at least 512 counts had been accumulated. For a

1174593

275-111

TABLE I

THE DISTRIBUTION OF F18 IN THE RAT 1/4, 1, 4 AND 9 HOURS AFTER INTRAVENOUS ADMINISTRATION. VALUES ARE EXPRESSED IN PERCENT OF ADMINISTERED DOSE AND ARE CORRECTED FOR DEVIATION OF RECOVERY FROM 100 PERCENT. THE 1/4, 1 AND 4 HOUR GROUPS CONSISTED OF 5 ANIMALS EACH, THE 9 HOUR GROUP OF 6 ANIMALS.

	1/4 hr. - 250 $\mu$ c		1 hr. - 190 $\mu$ c		4 hrs. - 70 $\mu$ c		9 hrs. - 280 $\mu$ c	
	Percent per organ	Percent per gram	Percent per organ	Percent per gram	Percent per organ	Percent per gram	Percent per organ	Percent per gram
Heart and Lung	1.18	0.60	0.19	0.11	0.08	0.03	0.06	0.03
Spleen	0.52	0.55	0.06	0.06	<0.01	<0.01	0.003	0.003
Blood	8.39	0.54	0.97	0.07	0.14	0.01	0.05	0.005
Liver	5.06	0.50	0.49	0.07	0.28	0.03	0.03	0.005
Kidney	1.52	0.88	0.27	0.18	0.04	0.03	0.03	0.02
Stomach	0.28	0.33	0.04	0.08	<0.01	<0.01	0.004	0.003
Stom. Cont.	0.06	-	0.09	-	<0.01	-	0.002	-
Sm. Int.	1.17	0.29	0.24	0.08	0.03	0.01	0.01	0.004
Sm. Int. Cont.	1.79	-	1.27	-	0.14	-	0.03	-
Lg. Int.	0.43	0.36	0.07	0.07	0.04	0.04	0.01	0.006
Lg. Int. Cont.	0.20	-	0.09	-	0.81	-	0.49	-
Cecum - Cont.	0.44	-	0.32	-	1.30	-	0.30	-
Bone	33.60	1.83	58.80	3.74	63.30	4.06	52.40	3.26
Muscle	20.10	0.19	6.77	0.08	1.14	0.01	0.73	0.009
Skin	11.40	0.30	2.26	0.08	0.28	0.01	0.15	0.005
Cartilage	-	0.33	-	-	-	-	-	0.66
Pancreas	-	0.43	-	-	-	<0.02	-	<0.002
Brain	-	-	0.02	0.02	0.01	0.01	0.006	0.003
Sal. Gland	-	1.28	-	0.08	-	0.01	-	<0.006
Lac. Gland	-	0.38	-	0.04	-	0.01	-	<0.004
Lymph Node	-	0.66	-	0.01	-	0.01	-	<0.015
Thyroid	0.001	0.05	0.002	0.10	-	-	<0.005	<0.025
Adrenal	0.04	-	0.004	-	<0.001	-	<0.002	-
Balance	8.51	-	14.70	-	6.20	-	12.70	-
Urine	4.84	-	11.9	-	25.80	-	31.90	-
Feces	0.04	-	1.28	-	0.36	-	1.09	-

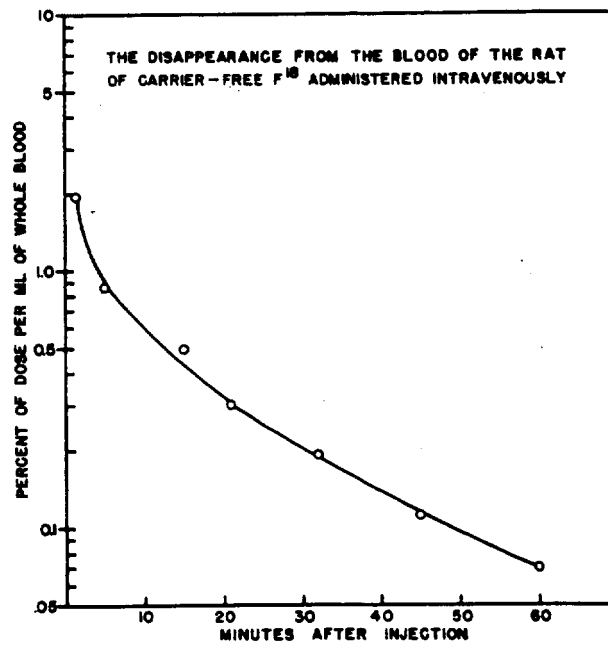

Figure 2

1174595

3230701

TABLE II

THE DISTRIBUTION IN THE RAT OF FLUORIDE TAGGED WITH  $F^{18}$  15 MINUTES AND 9 HOURS AFTER INTRAVENOUS ADMINISTRATION. VALUES ARE EXPRESSED IN PERCENT OF ADMINISTERED DOSE AND ARE CORRECTED FOR DEVIATION OF RECOVERY FROM 100 PERCENT. THE 15 MINUTE GROUP CONSISTED OF 5 RATS, THE 9 HOUR GROUP OF 3 RATS. EACH RAT RECEIVED 10 MGM/KILO OF F AS FLUORIDE.

	15 min. - 360 $\mu$ c		9 hr. - 500 $\mu$ c	
	Percent per organ	Percent per gram	Percent per organ	Percent per gram
Heart and Lung	0.93	0.46	0.025	0.008
Spleen	0.18	0.38	<0.005	<0.01
Blood	7.07	0.63	0.05	0.004
Liver	2.96	0.44	0.05	0.006
Kidney	3.37	2.47	0.019	0.011
Stomach	0.29	0.30	<0.005	<0.005
Stom. Cont.	0.05	-	0.011	-
Sm. Int.	1.24	0.36	<0.011	<0.004
Sm. Int. Cont.	1.33	-	0.025	-
Lg. Int.	0.46	0.36	0.006	0.004
Lg. Int. Cont.	0.14	-	1.00	-
Cecum + Cont.	0.40	-	0.49	-
Bone	39.8	3.00	56.9	3.16
Muscle	19.9	0.27	0.42	0.005
Skin	10.2	0.39	0.12	0.004
Cartilage	-	0.68	-	0.28
Pancreas	-	0.42	-	<0.001
Sal. Gland	-	0.68	-	<0.010
Lac. Gland	-	0.36	-	<0.01
Lymph Nodes	-	0.36	-	<0.01
Thyroid	0.006	0.30	<0.004	-
Adrenal	0.024	-	<0.004	-
Balance	10.3	-	7.78	-
Urine	1.12	-	32.2	-
Feces	0.16	-	0.84	-

1174596

TABLE III

THE DEPOSITION OF  $F^{18}$  IN THE RAT 1, 4 AND 9 HOURS AFTER ORAL ADMINISTRATION. VALUES ARE EXPRESSED IN PERCENT OF ADMINISTERED DOSE AND ARE CORRECTED FOR DEVIATION OF RECOVERY FROM 100 PERCENT. EACH GROUP CONSISTED OF 5 ANIMALS.

	1 hr. - 110 $\mu$ c		4 hr. - 530 $\mu$ c		9 hr. - 510 $\mu$ c	
	Percent per organ	Percent per gram	Percent per organ	Percent per gram	Percent per organ	Percent per gram
Heart and Lung	0.22	0.10	0.086	0.036	0.041	0.015
Spleen	0.06	0.08	0.007	0.01	0.002	0.004
Blood	1.25	0.10	0.14	0.014	0.075	0.005
Liver	0.54	0.10	0.068	0.011	0.041	0.006
Kidney	0.24	0.19	0.034	0.037	0.059	0.039
Stomach	1.18	1.48	0.66	0.77	0.50	0.56
Stom. Cont.	5.48	-	1.07	-	4.64	-
Sm. Int.	1.84	0.72	0.078	0.025	0.047	0.014
Sm. Int. Cont.	21.4	-	0.52	-	0.308	-
Lg. Int.	0.08	0.07	0.042	0.034	0.024	0.021
Lg. Int. Cont.	0.06	-	0.60	-	0.432	-
Cecum + Cont.	0.54	-	12.6	-	6.24	-
Bone	42.6	3.20	58.1	4.55	49.8	3.00
Muscle	4.87	0.068	0.77	0.012	0.565	0.006
Skin	1.71	0.064	0.18	0.008	0.484	0.014
Cartilage	-	0.43	-	0.46	-	0.29
Pancreas	-	0.07	-	0.008	-	0.004
Brain	0.022	0.02	0.012	0.008	-	-
Sal. Gland	-	0.10	-	0.011	-	-
Lac. Gland	-	0.077	-	0.014	-	-
Lymph Node	-	0.10	-	0.012	-	-
Thyroid	0.001	0.05	<0.001	-	-	-
Adrenal	0.005	-	<0.001	-	-	-
Balance	4.80	-	8.59	-	6.98	-
Urine	13.0	-	16.0	-	25.6	-
Feces	0.05	-	0.48	-	4.14	-

1174597

377-111

total of 512 counts accumulated and a ratio of total counting rate to background counting rate of 1.5 or less, the error introduced because of the statistical nature of particle counting is much greater than 10 percent (Ghelardi and Brown<sup>4</sup>). It will be noted in the tables and especially at the 9 hour period when the amount of radio-fluorine left in the samples is small that the radio-fluorine content of many of the tissues is indicated as less than the certain quantity. This quantity is the percent of the dose which is equivalent to one-half of the counter background.

With the exception of muscle, blood, bone and skin, whole organs were assayed. In the case of muscle and blood, the total radio-fluorine contents were calculated from the percent per gram of wet tissue and the assumption that these 2 tissues comprise 45 percent and 7 percent of the body weight respectively. These figures have been found to be reasonably accurate in the experience of this laboratory.

The radio-fluorine content of the entire skeleton was estimated by reducing the eviscerated carcass to ash, removing the soft tissue ash by washing with water, drying and weighing. The wet weight of the skeleton was then calculated as follows: the ash weight of skeleton divided by 0.375 equals the wet weight of the skeleton. The value of 0.375 for the ash content of fresh rat bone has been used in this laboratory for several years and agrees quite well with the value obtained by Ray and Asling<sup>5</sup> for the ash content of the normal bone of female rats in the age and weight range used in these experiments ( $0.366 \pm 0.0071$ ).

The percent of dose in the muscle, blood, bone and cartilage samples was added to the percent of dose obtained for the eviscerated skinned carcass. From this "total carcass", were subtracted the values for total blood, muscle and skeleton. The remainder which varied from 4.6 percent to 14.5 percent has been designated as balance. This consists of tissues such as: connective tissue, cartilage, glandular tissue, lymphoid tissue, fat, nervous tissue and blood vessels.

## Results

As can be seen from Figure 2 intravenously administered carrier-free radio-fluorine disappears from the blood with extreme rapidity. One minute after the injection only 25 percent of the injected material remained in the circulation and after 1 hour the amount remaining in the blood was negligible.

At the early time intervals (15 minutes after injection) the salivary glands concentrated carrier-free radio-fluorine to a greater extent than any other soft tissue. At later times, the salivary gland concentration paralleled the blood level. The kidney was the only soft tissue which consistently showed a radio-fluorine concentration greater than that of the blood. This is understandable since the excretion of radio-fluorine was chiefly urinary. The greater portion of the urinary excretion of radio-fluorine occurred in the first 4 hours after injection.

1174598



The radio-fluorine concentrations of the soft tissues other than the salivary glands and the kidney approximated that of the blood or were below it.

It is noted that the only major site of deposition of carrier-free radio-fluorine was in the bone and that such deposition was extremely rapid. The peak concentration of 63.3 percent of the administered dose was reached in 4 hours. During the following 5 hours about 17 percent of the maximum accumulation was lost. For easy comparison all values for the radio-fluorine content of the skeleton and the concentration of radio-fluorine per gram of wet bone are collected in Table IV which also includes the standard error of these values.

At the later time periods, except for bone, cartilage was the only tissue which concentrated carrier-free radio-fluorine to an appreciable extent.

When carrier-free radio-fluorine was given intravenously a certain amount reached the gut and although most of this was apparently re-absorbed some was excreted in the feces. That the radio-fluorine in the feces might possibly be due to contamination by the urine is disproved by its presence in the formed feces in the large bowel.

Comparing Tables I and II, it will be noted that the rat handles carrier-free radio-fluorine in almost the same fashion as it does when radio-fluorine is given with milligram amounts of stable fluoride with only a few notable exceptions and these only at the earliest time intervals. The initial urinary excretion seems to be slightly greater when carrier-free radio-fluorine is given. The concentration of carrier-free radio-fluorine in the kidney 15 minutes after injection is only one-half that present when weighable amounts are given. The salivary glands which are known to secrete fluoride (Volker et al<sup>6</sup>) concentrate twice as much radio-fluorine when it is given in the carrier-free state. The percent uptake of carrier-free radio-fluorine per gram of bone is about two-thirds that for the group receiving carrier-fluoride and although the total skeletal radio-fluorine uptake varies by only 16 percent, comparison of the computed  $t$  value of 5.1 with the table of  $t$  shown in Fisher<sup>7</sup>, gives a probability of less than 0.01 that this difference is due to chance.

Absorption of carrier-free radio-fluorine from the G. I. tract following oral administration is quite rapid as can be seen from Table III. Seventh-five percent of the administered dose is absorbed in the first hour and 90 percent by the end of 9 hours. Comparison of Tables I and III shows few significant differences between orally and intravenously administered carrier-free radio-fluorine except for the larger amounts of radio-fluorine

TABLE IV

THE STANDARD ERROR OF EXPERIMENTAL VALUES FOR F<sup>18</sup> UPTAKE IN SKELETON AND F<sup>18</sup> CONCENTRATION PER GM. OF BONE ARRANGED BY GROUPS. (STANDARD ERROR =  $\pm \frac{\Sigma d^2}{n(n-1)}$ )

<u>Experiment</u>	<u>Percent F<sup>18</sup> in skeleton</u>		<u>Percent F<sup>18</sup> per gm. bone</u>	
<u>Carrier-free</u>				
15 min. IV	33.6	±1.12	1.83	±0.07
1 hr. IV	58.8	±2.2	3.74	±0.16
4 hrs. IV	63.3	±1.4	4.06	±0.16
9 hrs. IV	52.4	±3.6	3.26	±0.17
1 hr. ST	42.6	±2.2	3.20	±0.26
4 hrs. ST	58.1	±2.5	4.55	±0.23
9 hrs. ST	49.8	±4.0	3.00	±0.26
<u>10 mg/kilo F</u>				
15 min. IV	39.8	±0.9	3.00	±0.18
9 hrs. IV	56.9	±1.6	3.16	±0.27

1174600

The recoveries of radio-fluorine in all of the tracer studies were in a few cases as low as 76 percent and as high as 120 percent but were generally between 87 percent and 95 percent of the administered dose.

### Discussion

The rapid disappearance of carrier-free radio-fluorine from the blood may explain in part the failure of other research workers to find high blood fluoride levels even in animals that had been fed high fluoride diets for long periods of time (Chang et al<sup>8</sup>). The high initial concentration of carrier-free radio-fluorine of the salivary glands and the large amount of radio-fluorine excreted in the urine in the first 4 hours confirms the results of Volker et al,<sup>5</sup> who states that salivary secretion of radio-fluorine and the major part of the urinary excretion of radio-fluorine occurred when the blood level was relatively high.

The fact that the concentration of radio-fluorine in the soft tissues paralleled the blood level and its relatively even distribution in the soft tissues indicates that radio-fluorine is readily able to both enter and leave the cells as are the other halides, (Smith et al<sup>9</sup>) and that the formation of a radio-fluoride complex with protein or phosphate on a measureable scale is unlikely.

One surprising fact brought out by this series of experiments was the almost negligible uptake of radio-fluorine by the thyroid since it has been shown that all of the other halides are accumulated in this gland to a measureable extent (Baumann and Metzger<sup>10</sup>, chlorine, bromine and iodine and Hamilton and Soley<sup>11</sup>, iodine and astatine). In no case was the percent of dose per gram of thyroid significantly greater than the concentration of radio-fluorine in the blood. From studies with radio-iodine, the peak of thyroid iodine content has been shown to occur about 24 hours after its administration. In view of this, it would not be logical to expect a large amount of radio-fluorine to accumulate in the thyroid 15 minutes after its injection. However, 9 hours after administration the amount of radio-fluorine in the thyroid was so small that even when the thyroids from 5 rats were pooled for assay the total counting rate was less than one and one-half times the counter background and this value was considered statistically insignificant. It is possible that when larger amount of fluorine are present in the circulation and thus available to the thyroid, measureable quantities might be accumulated as is indicated by the relatively higher concentration (0.3 percent gram) in the thyroid 15 minutes after administration of radio-fluorine and 10 mg/kilo of stable fluorine.

The high variable values obtained for balance may be due in part to a variable amount of cartilage present, but it is more likely due to an error introduced in the calculation of the percent of dose in the skeleton, in that the bone samples taken (the femur, tibia and fibula of the right hind

1174601

leg) may not be an entirely accurate index of the ability of the skeleton as a whole to take up fluoride. The latter argument is in part substantiated by an observation in a phase of this work still to be completed, that the mandible, a flat bone, accumulated radio-fluorine to a greater extent per unit weight than did the long bones. This was also noted by Volker et al<sup>6</sup>, and may be explained in part by the smaller marrow spaces of the flat bones and by their greater vascularity. In accord with the findings of Savchuk and Armstrong<sup>12</sup> that part of the fluorine initially deposited in bone is loosely bound and may be excreted when the fluorine in the blood reaches a low level, it was found that 17 percent of the peak skeletal radio-fluorine content 4 hours after its intravenous administration was lost during the following 5 hours.

The presence of radio-fluorine in the intestinal tract following administration by vein may be the result of several physiological processes; secretion in the saliva and subsequent swallowing, secretion by the gastric mucosa, secretion in the bile or in the pancreatic juices and absorption into the small intestine. The first two possibilities mentioned, salivary and gastric secretion, might account to a small extent for the presence of radio-fluorine in the gut, although the stomach contents were found to contain only negligible amounts of radio-fluorine 15 minutes after administration when radio-fluorine was found in the contents of the small intestine in appreciable quantities. Biliary and pancreatic secretions seem unlikely since at no time was the concentration of radio-fluorine in the liver or the pancreas significantly higher than that of the blood. From the information available at the present time direct passage into the small intestine seems to be the most likely route of entry of radio-fluorine into the G. I. tract, since it is known that water and ions are transported across the intestinal epithelium in both directions, (Visscher et al<sup>13</sup>). It is evident that absorption of carrier-free radio-fluorine from the intestine is not complete, since there was considerably more radio-fluorine found in the feces of animals that received radio-fluorine orally than those that received radio-fluorine by vein.

The rapid excretion of carrier-free radio-fluorine by the kidney indicates that if there is a renal threshold for fluorine, it is very low, since the amounts of radio-fluorine given represented less than 10<sup>-12</sup> of a mole. The kidney seems to handle radio-fluorine more efficiently, the smaller the amount of fluorine present, as shown by the higher initial concentration of radio-fluorine of the kidney when stable fluoride was added, compared to that when carrier-free radio-fluorine was given.

In view of the minor differences in radio-fluorine distribution between the groups receiving 10 mg/kilo of stable fluorine and those receiving material which was essentially carrier-free, and the work of numerous investigators reviewed by Roholm,<sup>14</sup> on the presence of fluorine in nearly every animal tissue, it is evident that when carrier-free radio-fluorine is administered, it is actually tagging the pool of fluorine already present in the animal body.

1174602

## BIBLIOGRAPHY

1. Snell, A. H., Phys. Rev., 51, 143A (1937). "A New Radioactive Isotope of Fluorine."
2. Blaser, J. P., Boehm, F., and Marmier, P., Phys. Rev. 75, 1953 (1949). The "Positron Decay of F18."
3. Jenkins, K. D., UCRL-1766, May, 1952. Scintillating Crystal Gamma Counter.
4. Ghelardi, R. P. and Brown, C. H., Nucleonics 1, 50 (1947). "Electronic Instruments for Use with Geiger-Muller Tubes."
5. Ray, C. D. and Asling, C. W., Unpublished Data.
6. Volker, J. F., Sogmaes, R. F. and Bibby, B. G., Am. S. Physiol. 132, 707, (1941). "Studies on the Distribution of Radioactive Fluorine in the Bones and Teeth of Experimental Animals."
7. Fisher, R. A., Statistical Methods for Research Workers. Edinburgh, Oliver and Boyd, 1950.
8. Chang, C. Y., Phillips, P. H., Hart, E. B., and Bohstedt, G., J. Dairy Sci., 17, 695 (1934). "The Effect of Feeding Raw Rock Phosphate on the Fluorine Content of the Organs and Tissues of Dairy Cows."
9. Smith, P. K., and Eiseman, A. J. and Winkler, A. W., J. Biol. Chem., 141, 555, (1941). "The Permeability of Human Erythrocytes to Radioactive Chlorine, Bromine and Iodine."
10. Baumann, E. J., and Metzger, N., Proc. Soc. Exp. Biol. Med., 70, 526 (1949). "Behavior of the Thyroid Toward Elements of the VII Periodic Group. I Halogens and Biocyanate."
11. Hamilton, J. G. and Soley, M. H., Proc. Natl. Acad. Sci., 26, No. 8 483 (1940). "A Comparison of the Metabolism of Iodine and of Element 85 (Eka-Iodine)."
12. Savchuck, W. B. and Armstrong, W. D., J. Biol. Chem., 193, 575 (1951). "Metabolic Turnover of Fluorine by the Skeleton of the Rat."
13. Visscher, M. B., Fechter, E. S., Jr., Carr, C. W., Gregor, H. P., Bushey, M. S. and Barker, D. E., Am. J. Physiol., 142, 550 (1944). "Isotopic Tracer Studies on the Movement of Water and Ions Between Intestinal Lumen and Blood."
14. Roholm, Kaj., Fluorine Intoxication. London, H. K. Lewis and Co. Ltd. 1937.

1174603

306211

## RADIOAUTOGRAPHY

### Astatine

C. W. Asling, J. G. Hamilton and Gretchen Thilo

In previous reports reference has been made to a young male Rhesus monkey which received 100 microcuries of astatine by injection into the anterior chamber of the eye. In July 1950 after a period of approximately 6 months, the animal developed signs and symptoms suggestive of lack of thyroid function; notably decreased tolerance to cold, loss of hair, decreased food intake, pouchiness beneath the eyes, apathy and decreased bowel movements as compared to the control animal which had received no astatine. It appeared at this time that growth had ceased. During the following year the monkey was observed to remain in approximately the same size and condition except for the almost complete loss of hair. In January of 1952, the animal received daily by oral administration from 6 to 12 mgm. of thyroid substance. The effect of this regimen was unquestionable. Within a month the intake of food had quadrupled and the animal was much more active, aggressive, and showed less intolerance to cold. Four and one-half months later the pelt appeared nearly normal. At this time the administration of thyroid substance was discontinued. Within 2 months there appeared the onset of the signs of hypothyroidism noted prior to the administration of thyroid substance. By July 1952, the monkey was in very nearly the same physical condition as it had been prior to the administration of the thyroid substance.

The pelt showed scanty hair and the skin appeared coarse and flaky with considerable desquamation. The right eye had been destroyed as a result of the astatine injection but there was evidence of no infection in this region.

Prior to sacrifice, x-ray films were obtained in areas where ossification might have been expected to have occurred in a monkey of this age which was approximately 3 years at the time he was sacrificed. Dr. G. van Wagenen of the Department of Obstetrics and Gynecology of the Yale University School of Medicine compared the films we obtained to those secured in her laboratory from monkeys whose ages were exactly known. In her opinion the estimated chronological age was less than 2-1/2 years while it was our opinion that the animal was at least 3 years of age. Her observations were based on the appearance of the bones of the elbow, no beginning fusion of the olecranon, and incomplete fusion of the distal end of the humerus. The secondary center of the head of the tibia was not present.

Twenty-four hours prior to sacrifice, the animal was given 100 microcuries of carrier-free radio-iodine by intraperitoneal injection. Before the animal was sacrificed, sufficient blood was secured so that a protein bound iodine determination might be made and the value obtained was 2.7 micrograms per 100 cc.

1174604

An autopsy the following tissue samples were sent to San Francisco for histological preparation; lacrimal gland, salivary gland, cervical lymph node, mesenteric lymph node, heart, muscle, aorta, thymus, stomach, small intestine, kidney, spleen, pancreas, lung and skin. The testis, pituitary, adrenal and bone specimens were sent to C. W. Asling for special preparation. The thyroid was held for radioautographic study. It was fixed in Bouins solution, dehydrated and embedded in paraffin in the usual fashion.

The subcutaneous fat was limited in amount and the coarse scaly quality of the skin was evident when skin specimens were taken. No visible thyroid tissue was present. However, by the use of an end-window Geiger counter shielded with a lead foil having a 1 mm aperture in the center it was possible to survey the trachea and dissect away those areas which had measurable amounts of radioactivity.

Most of the tissues were fixed in Bouins and embedded in paraffin and 5 micron sections prepared. In addition to these procedures blood counts were obtained at the time of sacrifice.

The single most interesting tissue was the thyroid gland. Less than 1 percent of the administered dose of radio-iodine had been accumulated and retained 24 hours after it had been given. The thyroid gland was shrunk and adequate dissection was only possible by the use of a dissection microscope and the shielded end-window counter. A few acini with colloid were found which appeared almost normal in character. More were small and had but little colloid. A noteworthy observation was that several acini had been invaded by polymorphonuclear leukocytes and from the radio-autographs it appeared that the region of the acini not invaded by leukocytes contained colloid and radio-iodine. In many regions there were clumps of atypical epithelial cells which preserved their capacity to accumulate and retain radio-iodine. In some instances atypical epithelial cells could be seen embedded within rather dense layers of fibrous tissues. One region was found in the right lobe containing a large number of anaplastic deeply staining cells. Although mitotic figures were not observed, cells of this character were also seen occasionally in regions where groups of epithelial cells were present that accumulated radio-iodine. A few regions were noted where there were present polymorphonuclear leukocytes which were external to the few surviving acini.

The overall impression was that of a very severe degree of thyroid injury with some apparent inflammatory reaction of a limited nature and the presence of cells appearing anaplastic in character. The parathyroid glands showed no evidence of injury whatsoever.

The blood picture was of interest. The red cell count being 3,300,000 and the leukocyte count was 2,300. The differential count was as follows: neutrophils 43 percent; lymphocytes 52 percent; eosinophils 1 percent; basophils 2 percent and monocytes 2 percent. Thus it appeared that this animal had a definite anemia and leukopenia.

1174605

Most of the salivary gland appeared to be of normal morphology. However, there were small sharply circumscribed areas whose structures appeared abnormal. The cells were markedly basophilic and their nuclei pyknotic. The cells lay in cords suggesting an acinar arrangement and appeared compressed so that the structure was dense. The lacrimal gland appeared nearly normal except for the presence of some fibrous tissue and a spotty but minor interstitial edema. The spleen and lymph nodes appeared normal; a finding which is difficult to reconcile with the apparent leukopenia that was present. In the astatine treated monkey the seminiferous tubules were not canalized and mitotic figures were found only after prolonged search. Interstitial cells infrequently were found and were occasionally foamy and large. The impression gained is that of a small testis as yet not functioning by production of either spermatozoa or hormone. More complete histological evidence will be available later.

The only changes to be observed in the liver were some cloudy swelling of the parenchyma. It has been anticipated that degeneration might have been present in view of the prolonged and severe state of myxedema. Heart, muscle, aorta, thymus, stomach, small intestine, kidney and pancreas all appeared to be normal.

Sections of skin from the treated monkey were taken from two regions, namely, chest and leg. The epidermis was thin and total thickness did not exceed 4 to 5 cell layers and virtually no proliferation was seen in the stratum germinativum. The surface had a moderate amount of shredded keratin. Hair shafts were slender and root structure presented only slight activity.

In addition to the testis, preparations are being made from the pituitary and adrenal glands. The testis, both adrenal glands and pituitary are in the process of being embedded in celloidin.

Additional monkeys were recently procured and an attempt is being made to repeat this experiment on at least 2 animals. However, these animals will have to be carefully watched for at least 2 months since they had to be treated for various types of worm infestations as well as amebic dysentery. These animals have to be in the best of physical condition before astatine will be administered. The dose level anticipated will be in the range of 200 microcuries/kilo and preliminary studies prior to administration of astatine include: protein bound iodine, bone studies and a sufficient number of blood counts to be of statistical significance. Particular interest is directed to the procurement of adequate control histological specimens.

1174606



## RADIATION CHEMISTRY

Irradiation of Acetic Acid, Formic Acid, and Glycine

Warren M. Garrison

In previous reports it was shown that succinic, tricarballic, malonic, malic, citric and several other as yet unidentified non-volatile acids are produced by irradiation of a gaseous solution of acetic acid with 35 Mev helium-ions. Succinic acid and tricarballic acid were identified as the principal products at radiation levels below  $10^{22}$  ev/ml. Radiation yield measurements have since been made for succinic and tricarballic acid and these results have been described in terms of a proposed reaction mechanism which adequately accounts for the observed values. The effect of beam intensity, acetic acid concentration and added succinic acid have been evaluated. This work is concerned in a separate report which is reproduced below.

Studies have continued on the identification and quantitative determination of products formed by irradiation of aqueous solutions of formic acid with 35 Mev helium-ions. Using  $C^{14}$  labelled  $HCOOH$  it was shown in a previously reported work that oxalic acid is the principal non-volatile product formed in a 0.008N  $HCOOH$ . Other unidentified products were observed using filter paper chromatography. In experiments now in progress, a detailed examination of the volatile and the non-volatile fractions are being made. Methods of partition chromatography on silicic acid columns are being used in the identification of non-volatile fractions. Preliminary results indicate that several of the unidentified products previously observed are acidic compounds. Similar studies are being made on irradiated oxalic acid solutions.

Experimental procedures are being developed for the separation and identification of products formed in the irradiation of aqueous glycine solutions. Organic fatty acids produced by radiation induced deamination reactions are separated from glycine and other nitrogen compounds by cation exchange methods using Dowex 50. Fatty acids are then separated by partition chromatography on silicic acid columns of the type previously employed in the acetic acid study. The cationic fraction which includes glycine and the nitrogen containing radiation products are separated by selective elution using the method of Stein and Moore (Cold Springs Harbor Symposium, 1951). Studies of radiation induced amination reactions are under way. Irradiated solutions of ammonium acetate, oxalate and glycolate have been found to give positive tests for amino acids using the ninhydrin method. The amino acid fractions are being separated by filter paper chromatography.

1174607

3000000

High Energy Helium-Ion Irradiation of Aqueous Acetic Acid Solutions\*

Warren M. Garrison, Herman R. Haymond, Donald C. Morrison  
Boyd M. Weeks, and Jeanne Gile-Melchert

Summary

A study has been made of products formed in solutions of acetic acid by reactions resulting from irradiation with cyclotron-produced helium-ions having an energy of 35 Mev. The non-gaseous products are principally dibasic and tribasic acids. Succinic acid is the main product at radiation doses below  $1 \times 10^{20}$  ev/ml. Tricarballic, malonic, malic and citric acids in addition to succinic acid are produced at the higher dose levels. A proposed mechanism accounts for the quantitative observations.

According to present concepts<sup>1-6</sup> of the mechanism of radiation induced reactions in dilute aqueous solutions, the primary chemical effect of radiation is the dissociation, by ionization and excitation, of water molecules to give hydrogen atoms and hydroxyl radicals. The observed chemical changes in irradiated solutions are attributed to subsequent reactions of the H and OH radicals with one another and with solute molecules. The relative amounts of those radicals that combine to form  $H_2$  and  $H_2O_2$  and of those that react with a particular solute depend upon the specific ionization density of the effective radiation. Most of the radicals formed along the track of a fast electron, e. g., in regions of low ion density, diffuse into the bulk of the solution and are available for reaction with solute molecules. In regions of high ion density, e. g., in heavy particle tracks, radicals are formed locally in high concentration. Under these conditions many of the H and OH radicals are not subsequently available for reaction with dissolved organic material because they combine to form  $H_2$  and  $H_2O_2$  before they have time to diffuse into the bulk of the solution.

By reason of the fundamental relationships between ionization density and radiation yield in chemical and biological systems,<sup>2, 6, 7</sup> it has seemed desirable to us to investigate the qualitative and quantitative effects of heavy particle radiation on aqueous solutions containing organic solutes, particularly those of possible biological interest, and to establish the dependence of the observed effects upon the type of particle and its energy. The present paper<sup>8</sup> reports a study of products formed in dilute aqueous acetic acid solution by irradiation with high-energy helium-ions from the 60-inch cyclotron at the Crocker Laboratory. The greater part of this study was directed toward the problems associated with the separation, identification and quantitative determination of the non-gaseous products. Some indication of the possible nature of this fraction is suggested

---

\* Presented before the Division of Physical Chemistry, 122nd Meeting of the American Chemical Society, Atlantic City, N. J., September 14-19, 1952.

in studies of the effects of x-rays on aqueous acetic acid published several years ago by Fricke, Hart and Smith.<sup>9,10</sup> They suggested on the basis of indirect evidence obtained from gas analytical data and from pH measurements that succinic or glycolic could be the principal non-gaseous product. No direct chemical evidence was reported. In the present work a detailed investigation of non-volatile acid products was undertaken. Recently developed methods of partition chromatography on silicic acid columns were extensively employed. Product identification was greatly facilitated by the addition of  $\text{CH}_3\text{C}^{14}\text{OOH}$  to the target solutions.

### Experimental

Target cells of the type represented in Figs. 1 and 2 were used in studies involving the identification and yield determination of non-volatile products. Cell No. 1 had a solution capacity of approximately 10 ml. One side of the cell was drawn in to give a window (A) which had an average thickness of 3 mil over the bombarded area. A stream of gas (oxygen or helium) was forced through the fritted-glass disc (B) to stir the solution during irradiation and to control the oxygen concentration in the bulk of the solution. Cell No. 1 was supported in the bracket (C) which was attached through the snout (D) to the target shutter assembly shown in Fig. 3. Quantitative yield data were obtained using cell No. 2 which had a solution capacity of approximately 80 ml. Oxygen or helium was passed through the inlet (A) during irradiation. The replaceable glass windows (B) had an average thickness of from 1 to 3 mil and were supported in the standard-taper joint (C) which in turn fitted over the tapered metal snout of the target shutter assembly.

An expanded diagram of the target shutter assembly is shown in Fig. 3. The cyclotron beam entered the front plate (1) and was delimited by the water-cooled aperture (2). The defined beam then passed through a one mil aluminum foil (4) which was retained in position by the plate (3) and the shutter arrangement (5, 5a). The irradiation period could be accurately controlled by the shutter (5b). The beam monitoring circuit is shown schematically. The maximum error in beam current measurement was  $\pm 0.3$  percent.

The energy of the helium-ion beam was evaluated from range-energy relationships and from calorimetric data. Absorption measurements in aluminum gave a calculated<sup>11,12</sup> value of 40.4 Mev for the mean energy of the "naked" helium-ion beam. The calorimetric method, to be reported in detail elsewhere, gave an average beam energy of 40.2 Mev. Energy degradation in the aluminum window (4), in the cell window, and in the air space between was calculated from theoretical range-energy data.<sup>11,12</sup>

Hydrogen peroxide and organic peroxides were determined separately using a modification of the method of Greenspan and MacKellar<sup>13</sup> which is based on the observation that hydrogen peroxide, unlike organic peracids and hydroperoxides, is oxidized at temperatures from 0 to 10° C.

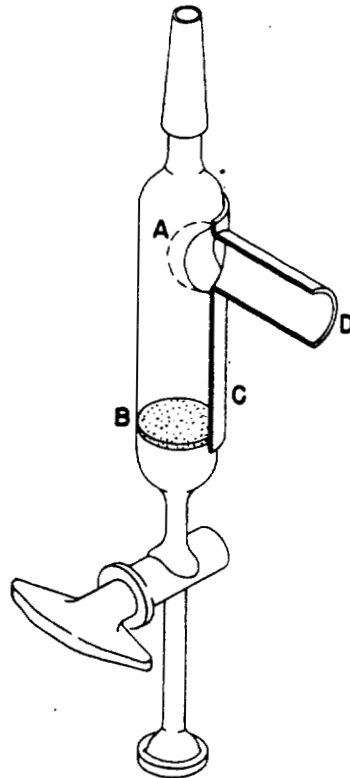

Figure 1: Target cell No. 1

1174610

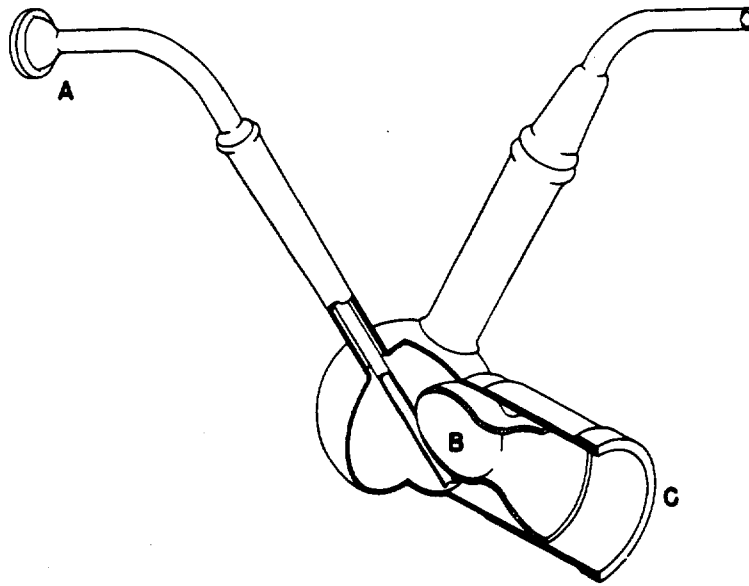

Figure 2: Target cell No. 2

1174611

3134711

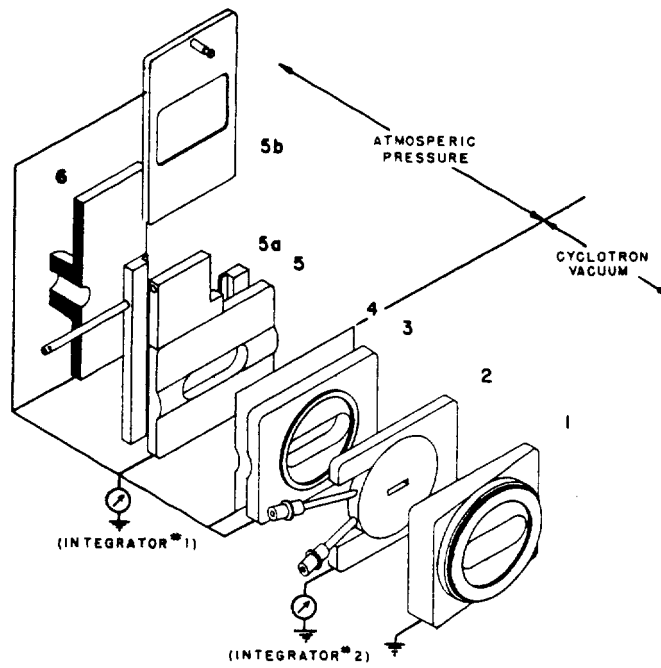

Figure 3: Target shutter assembly and beam monitoring circuit.

1174612

by ceric sulfate. Organic peroxides are then reduced with potassium iodide in excess and the solution is titrated with standard thiosulfate. In the present study, an aliquot of the target solution was added to an equal volume of 6N sulfuric acid and the resultant solution was titrated in the cold with 0.01N ceric sulfate-1.0N sulfuric acid solution to the ferroin end point. Potassium iodide was then added in excess and the solution was titrated with 0.01N sodium thiosulfate; in no case did the thiosulfate titre amount to more than 0.05 ml. Control analysis of simulated target solutions containing acetic acid, hydrogen peroxide, and peracetic acid were reproducible to within  $\pm 1$  percent.

Separation and identification of acid products was accomplished by application of recently developed methods of partition chromatography.<sup>14-16</sup> The column dimensions and methods of column preparation in the present work were a duplication of those developed by Marvel and Rands<sup>14</sup>. The developing liquids had the following composition:

1-	chloroform	
2-	5 percent n-butanol	95 percent chloroform V/V
3-	10 percent	90 percent
4-	15 percent	85 percent
5-	20 percent	80 percent
6-	25 percent	75 percent
7-	30 percent	70 percent
8-	40 percent	60 percent
9-	50 percent	50 percent
10-	70 percent	30 percent
11-	80 percent	20 percent
12-	85 percent	15 percent
13-	90 percent	10 percent
14-	95 percent	5 percent
15-	100 percent	0

Several different solvent sequences were employed depending upon the particular analytical problem involved. Unless otherwise stated, the solvents listed below were water saturated. Method A is essentially the standard separation procedure reported by Marvel and Rands<sup>14</sup>.

Method A - 100 ml each solvents 1 through 10.

B - 20 ml each solvents 1 through 7, 100 ml each solvents 8 through 10.

- Method C - 20 ml each solvents 1 through 7, 100 ml each solvents 8 through 10, 20 ml each solvents 11 through 15.
- D - 20 ml each solvents 1 through 4, 100 ml each solvents 5 through 8.
- E - 20 ml each solvents 1 through 3, 100 ml each solvents 4 through 6.
- F - 100 ml each solvents 5 through 7.
- G - 100 ml each solvents 1, 3, 5, 7, 8 and 9. All solvents saturated with 0.5 N hydrochloric acid.
- H - 350 ml 35 percent n-butanol - 65 percent chloroform saturated with 0.5 N hydrochloric acid.
- I - 400 ml 25 percent n-butanol - 75 percent benzene saturated with 0.1 N hydrochloric acid.

Water from a Barnstead still, redistilled in pyrex from alkaline permanganate was used in the preparation of the target solutions. Baker and Adams reagent grade glacial acetic acid was redistilled twice; the middle fraction (approximately 30 percent) was retained each time. The  $\text{CH}_3\text{Cl}^{14}\text{OOH}$  was prepared from the sodium salt by distillation in vacuo from phosphoric acid solution.<sup>17</sup>

### Results and Discussion

In preliminary studies, 80 ml volumes of 0.25 M acetic acid containing from 150 to 200 microcuries of  $\text{CH}_3\text{Cl}^{14}\text{OOH}$  were irradiated in cell No. 2 with 35 Mev helium-ions at a beam intensity of 1.0 microamperes. Oxygen was bubbled through the solutions during exposure. After irradiation, the target solutions were distilled to dryness in vacuo at room temperature. The non-volatile fraction was dissolved in 2-3 ml of butanol and chromatographed using method A which was employed as the general survey method in the present work. A 1 ml aliquot of each 10 ml of the effluent was evaporated to dryness in a porcelain dish under a heat lamp and assayed for  $\text{Cl}^{14}$  activity. The top curve in Fig. 4 shows a typical elution curve for a total dose of  $44.6 \times 10^{20}$  ev/ml. The lower curve in Fig. 4 gives the corresponding titres obtained by titrating with 0.02 N sodium hydroxide the remaining 9 ml of each 10 ml eluant volume. The similarities between the two curves shown in Fig. 4 indicate that the  $\text{Cl}^{14}$  activity corresponds to labelled non-volatile acids produced in the bombardment. At lower radiation doses fewer product peaks were observed. Below a dose of  $1 \times 10^{20}$  ev/ml, peak (I) only appeared. Acids corresponding to peaks (I) and (III) were the main products in the dose range of  $1 \times 10^{20}$  ev/ml to approximately  $10 \times 10^{20}$  ev/ml. Above this level all of the peaks seen in Fig. 4 were

1174614



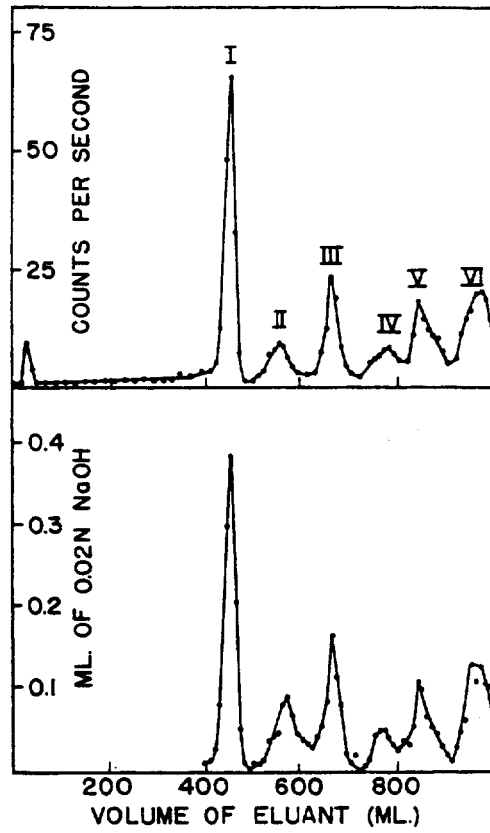

Figure 4: Chromatographic separation of non-volatile fractions: Method A; radiation dose,  $44.6 \times 10^{20}$  ev/ml.

1174615

present in the elution curves. For the identification studies reported below products in peaks (I) through (VI) of higher specific activity were obtained by irradiating, in cell No. 2, 10 ml volumes of 0.25 M acetic acid solution containing 250 to 300 microcuries of  $\text{CH}_3\text{C}^{14}\text{OOH}$ . In this way it was possible to isolate the product peaks in amounts which gave  $\text{C}^{14}$  counting rates of several hundred counts per second and a titre of less than 0.01 ml with 0.01 N sodium hydroxide.

A sample of  $\text{C}^{14}$  activity associated with (I) was co-chromatographed with added authentic succinic acid using method E. An exact correspondence of  $\text{C}^{14}$  activity and titre was obtained. A second sample of (I) was co-chromatographed with authentic succinic acid using method G. Exact correspondence between activity and titre was again obtained. These data are summarized in Fig. 5. Milligram amounts of (I) were subsequently isolated from 500 ml of 0.25 M acetic acid solution which received a total bombardment of  $40 \times 10^{20}$  ev/ml. After two recrystallizations from ether (I) melted at 182-184° C. A mixture of (I) and authentic succinic acid melted at 182-184° C.

Fraction (III) was originally suspected of being glycolic acid. An aliquot of  $\text{C}^{14}$  activity in (III), however, did not co-elute with added authentic glycolic acid using chromatographic method A. Subsequent work showed (III) to be tricarballic acid. A correspondence of activity and titre was obtained in co-chromatographs of (III) with authentic tricarballic acid using three different methods of partition chromatography as shown in Fig. 6.

Fractions (II), (V) and (VI) were found to contain malonic, malic, and citric acid respectively. Only those methods used in the isolation and identification of malonic acid in (II) will be presented in detail because the results obtained were essentially duplicated in the identification of malic and citric acids using similar procedures. Because the peak effluent volume of (II) corresponded approximately with that reported for malonic acid, a sample of  $\text{C}^{14}$  activity from (II) was co-chromatographed with authentic malonic acid using method A. The elution curve is shown in Fig. 7. Similar curves were obtained for (V) with malic acid and for (VI) with citric acid using methods B and C respectively. The small displacement in the relative position of the titre and activity curves shown in Fig. 7 was found to be a result of the fact that (II) contains several as yet unidentified acids which co-elute with malonic acid when chromatographic method A is used. This may be observed in Fig. 8 which shows an elution curve obtained by co-chromatographing a sample of (II) with added malonic acid using method G. Part of the  $\text{C}^{14}$  activity associated with (II) is seen to correspond with malonic acid. A sample of this fraction (II-1) was then chromatographed using method F. The correspondence of activity and titre is shown in Fig. 9. Peaks (V) and (VI) were both fractionated using method H and each was found to contain several acids in addition to malic and citric as indicated above. In subsequent work it was possible to separate malonic

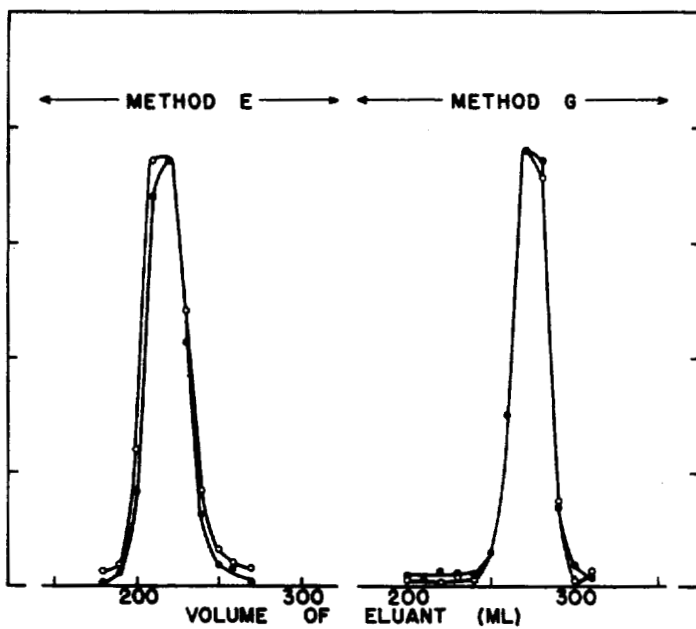

Figure 5: Co-elution of fraction I with authentic succinic acid: O, activity; O, titre.

1174617

3.1.2.1.1

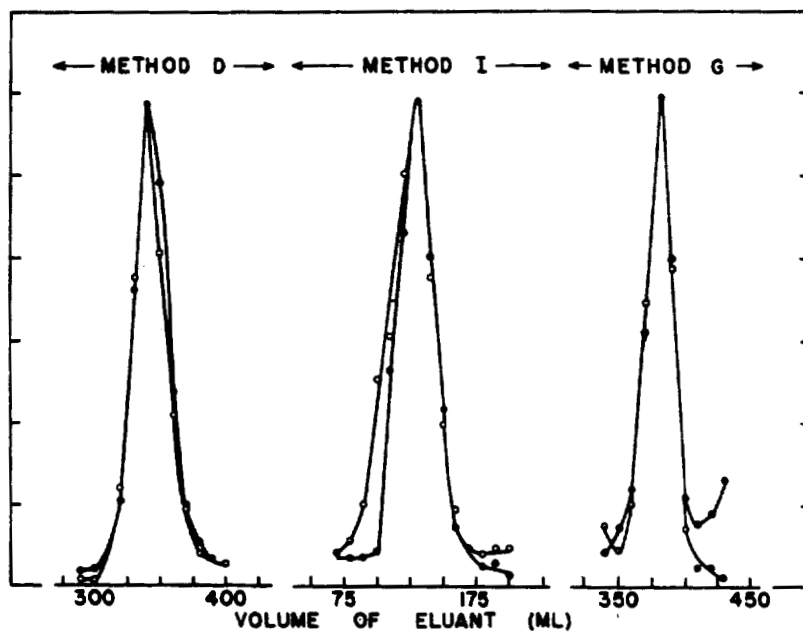

Figure 6: Co-elution of fraction III with authentic tricarballic acid.

1174618

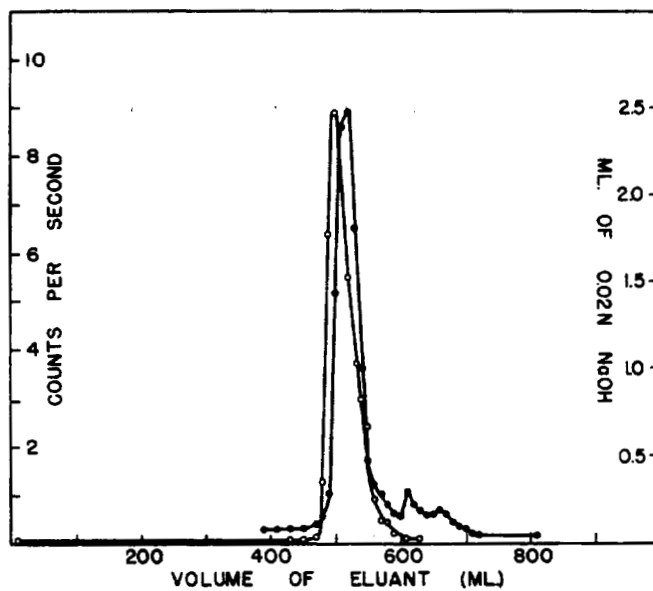

Figure 7: Co-elution of fraction II with authentic malonic acid: Method A.

1174619

3530711

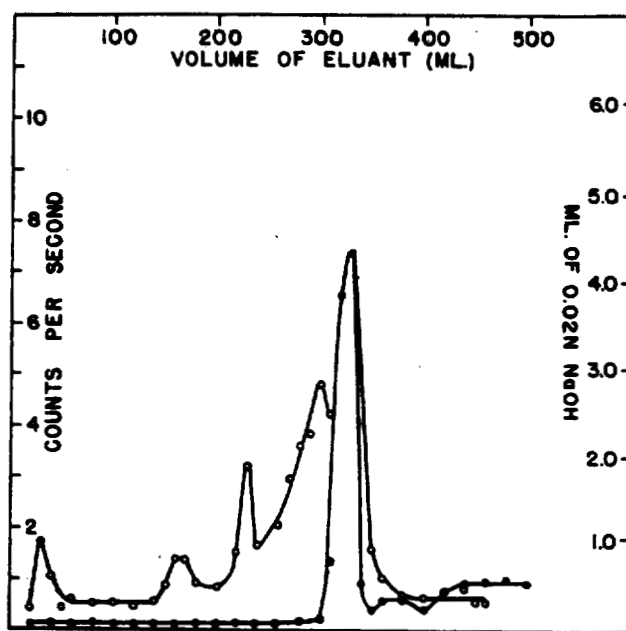

Figure 8: Co-elution of fraction II with authentic malonic acid: Method G.

1174620

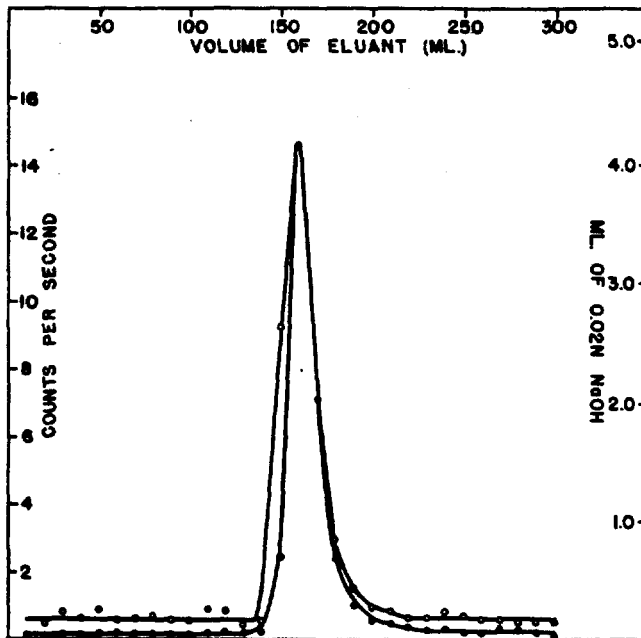

Figure 9: Co-elution of fraction II-1 with authentic malonic acid: Method A.

1174621

SSS 111

acid in milligram amounts from (II) by fractional crystallization from ether-benzene mixtures. Identification was based on melting point and mixed melting point determinations. The isolated product (II-1) melted at 132-133° C. A mixture of (II-1) with authentic malonic acid melted at 132.5-134° C. Aniline and para-toluidine salts of (II-1) were prepared and these showed no depression in melting point when mixed with authentic material.

Cell No. 2 was used for the quantitative studies. In the determination radiation yields for succinic and tricarballic acids, the target solutions were evaporated to dryness in vacuo at room temperature. The non-volatile acids were chromatographed using method A. Each 10 ml volume of the eluant was titrated directly with standard 0.01N or 0.02N aqueous sodium hydroxide to the phenolphthalein end point after the addition of 15 ml of methanol and 5 ml of water to give a homogenous solution. The total milliequivalents of product acid were calculated for the succinic and tricarballic peaks after correcting for a small background titration. Control determinations of succinic and tricarballic acids in simulated acetic acid target solutions gave recoveries of 97 to 102 percent. Fig. 10 gives the concentrations of succinic and tricarballic acids as a function of dose in 0.25 M acetic acid solution irradiated with 35 Mev helium-ions at a beam intensity of one microampere; oxygen was bubbled through the solution during the irradiation. The effluent gas was passed through a dry-ice trap and then through a series of two scrubbing traps containing standard 0.05 N sodium hydroxide solution. The amount of carbon dioxide produced was a linear function of the dose; the radiation yield was 0.070 carbon dioxide molecules/100 ev. The corresponding hydrogen peroxide concentrations as determined by the ceric sulfate method are shown in Fig. 11. Organic peroxides were not detected.

Since the acetic acid concentration in the irradiated target solutions remains essentially constant over the entire dose range represented in Fig. 10, it is apparent that the succinic acid and tricarballic acid are each approaching a stationary concentration at which the rates of production and removal are equal. The production of succinic acid and tricarballic acid is most readily accounted for by assuming that the  $\text{CH}_2\text{COOH}$  radical is formed as an intermediate<sup>18</sup>. In separate experiments it was found that the radiation yields of succinic and tricarballic acids are not influenced by dissolved oxygen and that these acids are not produced in 0.25 acetic acid solutions containing 1.0 M ferrous sulfate. The data strongly suggest that the  $\text{CH}_2\text{OOH}$  radical is formed by the reaction

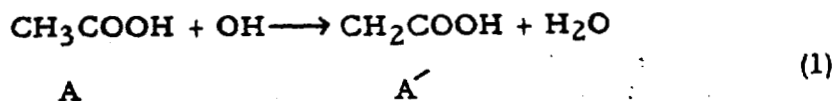

1174622



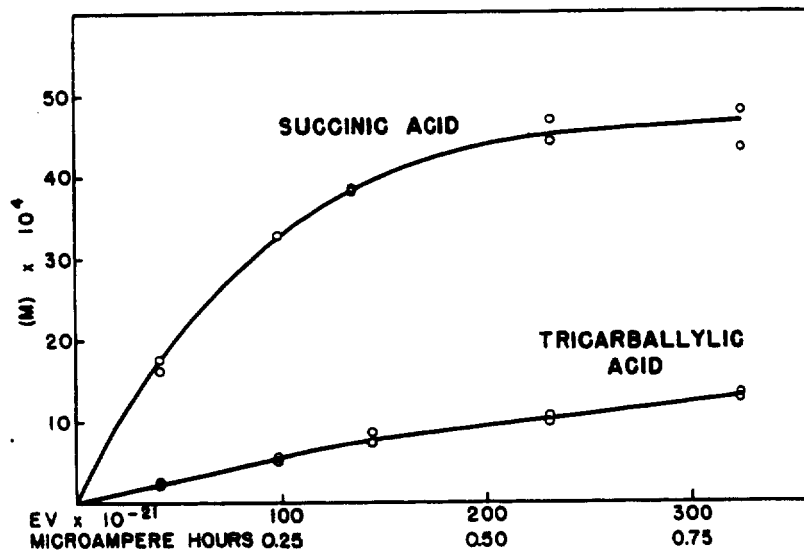

Figure 10: Production of succinic and tricarballylic acids.

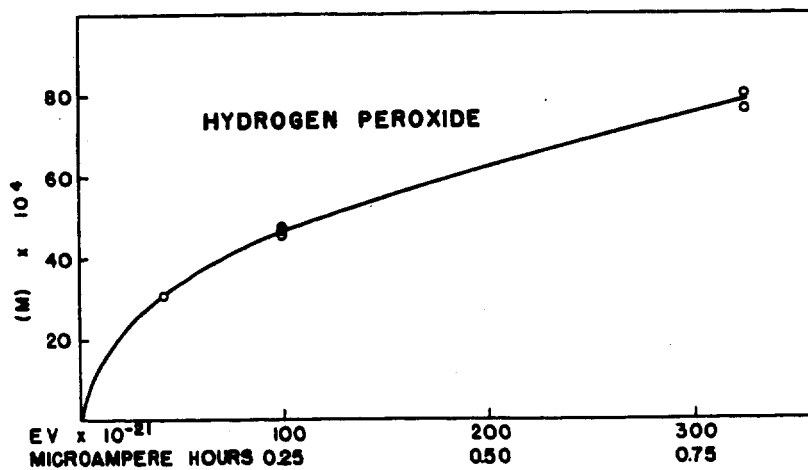
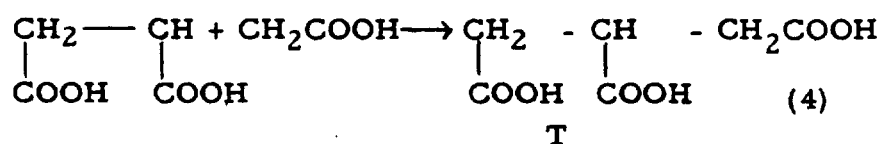
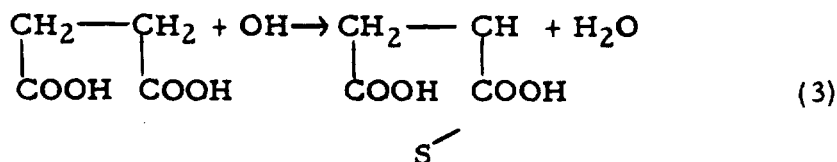
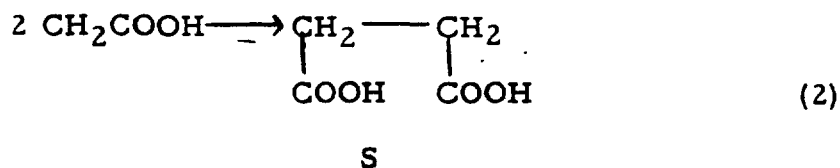

Figure 11: Production of hydrogen peroxide.

1174624

Succinic and tricarballic acids are then formed by the following sequence:



Since succinic acid and tricarballic acid are the principal products below a dose level of  $1 \times 10^{21}$  ev/ml it is possible to evaluate the proposed mechanism in terms of the observed rates of production of the two acids in this dose region. If we apply the usual procedures for deriving a rate law from a mechanism and assume that the rates of change of radical concentrations are small compared to their rates of production and removal we obtain the relationships:

$$\begin{aligned} d(S)/dt &= k_2 (\dot{A})^2 - k_3(S)(\text{OH}) \\ d(T)/dt &= k_4 (\dot{A})(\dot{S}') \\ k_1 (A)(\text{OH}) &= k_2 (\dot{A})^2 + k_4 (\dot{A})(\dot{S}') \\ k_3 (S)(\text{OH}) &= k_4 (\dot{A})(\dot{S}') \end{aligned}$$

from which the following expression is readily obtained:

$$\frac{k_1}{k_3} = \frac{(S)}{(A)} \left[ \frac{d(S)/dt}{d(T)/dt} + 2 \right] \quad (5)$$

The ratio  $k_1/k_3$ , i. e. the ratio of the rate constants for the reactions of OH with acetic acid and succinic acid, has been calculated according to equation

(5) from succinic acid and tricarballic acid yield data which were obtained under several different target conditions at a constant dose of  $1.01 \times 10^{21}$  ev/ml (0.20 microampere hours).

The effect of acetic acid concentration on the ratio of rate constants,  $k_1/k_3$ , and on the radiation yields of succinic acid and tricarballic acid is shown in Table I A. The calculated ratio  $k_1/k_3$  is reasonably constant over an acetic acid concentration range of from 0.0625 to 1.0 N. The radiation yield for succinic acid increases from 0.05 to 0.27 over the corresponding concentration range. At the higher acetic acid concentrations the succinic acid approaches a limiting concentration as the acetic acid molecules compete more effectively for OH radicals. The ratio  $k_1/k_3$  and the radiation yields are independent of beam intensity as shown in Table I B. The effect of added succinic acid is shown in Table I C. In accordance with the proposed mechanism, the addition of succinic acid results in a decrease in the radiation yield of succinic acid and an increase in the yield of tricarballic acid without effecting the  $k_1/k_3$  ratio. These results indicate that the proposed mechanism for the lower dose region is in good agreement with the experimental results. At higher doses, the kinetics become considerably more complex because of the reactions of succinic and tricarballic acids to give malic and citric acids respectively and because of the formation of malonic acid and several other as yet unidentified acid products; these reactions will be discussed in a later paper.

#### Acknowledgements

The authors wish to express their appreciation to Professor J. G. Hamilton, Director of Crocker Laboratory for his interest in this work and to Professor G. K. Rollefson for advice and suggestions during the course of the investigation. We also wish to thank Mrs. Harriet Powers for most of the chromatographic separations, Miss Margaret Gee for the preparation of the figures and Mr. B. Rossi and the staff of the 60-inch cyclotron at the Crocker Laboratory for assistance in target design and for the bombardments.

TABLE I

Radiation Yields of Succinic Acid and Tricarballic Acids.  
Target Volume, 75 ml; Dose,  $1.01 \times 10^{21}$  ev/ml (0.20  $\mu$ a hr.).

## A. Effect of acetic acid concentration

Beam current, 1 microampere.

Acetic Acid Concen. M	Succinic Acid		Tricarballic Acid		$k_1/k_3 \times 10^2$ Calcd. (5)
	Concen. M x $10^4$	Yield mol/100 ev.	Concen. M x $10^4$	Yield mol/100 ev.	
0.0625	8.85	0.049	1.95	0.011	9.25
	9.35	0.052	2.26	0.013	9.20
0.125	17.7	0.098	5.73	0.032	7.22
	16.83	0.093	3.37	0.020	9.20
0.25	26.0	0.144	4.0	0.022	8.40
0.50	40.7	0.226	4.86	0.027	8.50
	37.6	0.209	5.01	0.028	7.26
1.0	49.6	0.274	3.96	0.022	7.25
	49.6	0.274	4.12	0.024	7.01

1174627

310600

## B. Effect of intensity

Acetic acid, 0.25 M

Beam current microamperes	Succinic Acid		Tricarballic Acid		$k_1/k_3 \times 10^2$ Calcd. (5)
	Concen. M x 10 <sup>4</sup>	Yield mol/100 ev.	Concen. M x 10 <sup>4</sup>	Yield mol/100 ev.	
1.0	26.0	0.144	4.0	0.022	8.40
0.5	26.8	0.149	4.5	0.025	8.55
	26.2	0.145	4.21	0.0234	8.62
0.2	26.4	0.147	2.97	0.0165	10.80
	25.6	0.143	2.60	0.0145	11.00

## C. Effect of added succinic acid

Acetic acid, 0.25 M; succinic acid, 0.003 M; beam current,  
1 microampere.

	Succinic Acid		Tricarballic Acid		$k_1/k_3 \times 10^2$ Calcd. (5)
	Concen. M x 10 <sup>4</sup>	Yield mol/100 ev.	Concen. M x 10 <sup>4</sup>	Yield mol/100 ev.	
	48.6	0.102	8.99	0.049	7.77
	44.1	0.078	6.26	0.035	7.50

1174628

## BIBLIOGRAPHY

1. J. Weiss, *Nature*, 153, 748 (1944).
2. (a) A. O. Allen, *J. Phys. Colloid Chem.*, 52, 479 (1948); (b) A. O. Allen, C. J. Hochanadel, J. A. Ghormley, and T. W. Davis, *J. Phys. Chem.*, 56, 575 (1952); (c) E. R. Johnson and A. O. Allen, *J. Am. Chem. Soc.*, 74, 4147, (1952).
3. E. J. Hart, *J. Am. Chem. Soc.*, 73, 68 (1951); *J. Phys. Chem.* 56, 594 (1952).
4. F. S. Dainton, *J. Phys. Colloid Chem.*, 52, 490 (1948).
5. J. L. Magee and M. Burton, *J. Am. Chem. Soc.*, 73, 3270 (1951).
6. J. L. Magee, *J. Am. Chem. Soc.*, 73, 3270 (1951).
7. D. E. Lea, *Brit. J. Radiol. Suppl.*, 1, 59, (1947); *Actions of Radiation on Living Cells*, Cambridge University Press, London, (1946).
8. See also: (a) W. M. Garrison and G. K. Rollefson, *Discussions Faraday Soc.*, 11 (in press) (1952); (b) W. M. Garrison, D. C. Morrison, H. R. Haymond and J. G. Hamilton, *J. Am. Chem. Soc.*, 74, 4216 (1952).
9. H. Fricke and E. J. Hart, *J. Chem. Phys.*, 2, 824 (1934).
10. H. Fricke, E. J. Hart and H. P. Smith, *J. Chem. Phys.*, 6, 229 (1938).
11. W. A. Aron, B. G. Hoffman and F. C. Williams, AECU-663 (1949).
12. B. Rossi and B. Jones, Private Communication.
13. F. P. Greenspan and D. G. MacKellar, *Anal. Chem.*, 20, 1061 (1948).
14. C. S. Marvel and R. D. Rands, Jr., *J. Am. Chem. Soc.*, 72, 2642 (1950).
15. W. A. Bulen, J. E. Varner and R. C. Burrell, *Anal. Chem.*, 24, 187 (1952).
16. A. C. Neish, *Can. J. Research*, B27, 6 (1949).
17. We wish to thank Dr. Bert M. Tolbert for supplying the  $\text{CH}_3\text{Cl}^{14}\text{OOH}$  used in these experiments.
18. I. M. Kolthoff and A. I. Medalia, *J. Am. Chem. Soc.* 71, 3784 (1949).

1174629

Publications which have appeared:

1. Garrison, Warren M., Morrison, D. C., Haymond, H. R. and Hamilton, J. G.: High Energy Helium-Ion Irradiation of Formic Acid in Aqueous Solution. J. Am. Chem. Soc., 74, 4216 (1952).
2. Morrison, D. C.: Sulfonate Esters of Halogenated Phenols in Grignard Preparations (1). J. Am. Chem. Soc. 74, 3431 (1952).
3. Asling, C. W., Hamilton, J. G., Axelrod-Heller, Dorothy and Louie, Berniece Jue: The Localization of Certain Alkaline and Rare Earth Elements in the Costochondral Junction of the Rat. Anat. Record, 113, 285-300 (July, 1952).
4. Morrison, D. C.: Preparation of Radioactive Iodotriphenylethylene. J. Am. Chem. Soc., 74, 4459 (1952).
5. Morrison, D. C.: Grignard Preparation of Fluorene-2-Carboxylic Acid (1). J. Am. Chem. Soc., 74, 3430 (1952).

Submitted for publication:

1. Garrison, Warren M. and Rollefson, G. K.: Radiation Chemistry of Aqueous Solutions Containing Both Ferrous Ion and Carbon Dioxide.
2. Garrison, Warren M., Haymond, H. R., Powell, H., Corum, C., Hamilton, J. G.: A Centrifugal-Pump Target Assembly for the Cyclotron Bombardment of Liquids.
3. Morrison, D. C. and Crowley, Josephine F.: The Biological Behavior of Organic Compounds Containing Radiophosphorus.
4. Hamilton, J. G.: Astatine Data.

Publications in progress:

1. Garrison, Warren M., Haymond, H. R., Morrison, D. C., Weeks, B. M., Melchert, J. G.: High Energy Helium-Ion Irradiation of Aqueous Acetic Acid Solutions.

1174630



### III. HEALTH PHYSICS AND CHEMISTRY

#### Health Chemistry

N. B. Garden

#### Equipment Development Group

The equipment development group is now involved full scale on a long-range program of irradiations in the Idaho Falls reactor. This program involves both the preparation of the samples to be irradiated and the designing and building of equipment for processing them after irradiation. Equipment prepared by this group is being set up both at Berkeley and at Idaho Falls, the latter location to be used for short-lived samples; some equipment for irradiations from this reactor is being made for installation at Livermore for California Research and Development Corporation. The processing of these samples will in general involve handling samples in hundred-curie levels; slug opening and other initial steps will be done in the six-inch straight-type cave, with supplemental lead if necessary. As mentioned in the previous quarterly report, this cave now has a six-inch-lead-equivalent lead glass window and a pair of uranium ball-socket manipulators, which new features were successfully used in the processing of irradiations from the Chalk River reactor. For the Idaho Falls program a second lead glass window will be installed, and sketches for the new cave panel have been completed.

The equipment to be set up behind the six-inch lead panel will consist of box units containing a chain drive manipulator (one to each box), with hydraulically operated tongs. The manipulators will be set in such a position that they will be able to sweep over all chemical operations in the box unit and will be in contact with the interchange box provided for each unit. The side walls of the boxes will be made of lucite, allowing vision through the lead glass windows not only into the box directly in front of them but into the neighboring boxes. The ball-socket manipulators will be used for incidental and emergency operations.

The chemistry to be done subsequent to the operations in the six-inch cave, which is usually done in the plywood Berkeley boxes when handling lower levels of activity, will have to be performed in the two-inch lead-shielded boxes, and these setups are being readied.

Arrangements are being made to transfer the hundred-odd curies of  $\text{Co}^{60}$  from storage containers to the permanent housing of this source; this work will be partially done in the six-inch lead cave. Plans are being made to remove the oxide coating from the cobalt pellets before loading.

1174631

523711

The milking of the metal plutonium slugs from Los Alamos for the acquisition of americium was completed, save for the fraction recovered from the spill, also previously described. The purification of the recovered americium has been under way. Unexpected impurities in this material greatly complicated and prolonged the work; and the accompanying radiation necessitated special equipment, including a modified Berkeley Box, whose features included four ports (two for use with ball-socket manipulators and two in which gloves can be fitted), lead sheeting on the glove port panel, etc.

Equipment is being set up in Bldg. 5A annex for the milking of four more plutonium cows; the process will be carried out primarily through anion and cation columns, eliminating the equipment-taxing and involved precipitation methods used previously. The fraction recovered from the metal slugs, mentioned above, is about to be put through this pilot plant as a trial run. Drawings have been made of this cow equipment.

The modified target assembly for the bombardment of large quantities of heavy alpha emitters in the 60-inch cyclotron (the modifications consisted of filters integral with all vacuum and air lines leading off the target assembly so that on detaching the lines to remove the assembly, all activity is entrapped, regardless of possible failure within the target during bombardment) has been successfully used four times, the highest target content being approximately 10 curies. Further precautions are being considered for the bombardment of even much greater quantities.

The processing of neptunium-containing materials from Hanford in gloved box setups has been completed.

Miscellaneous small items created for use in radioactive chemical processing and handling include: arrangements whereby columns in lead boxes can be interchanged by tongs; an electronic model welder for use in making plastic bag-type liners, which are to be used in certain cases instead of lining the individual panels of gloved boxes; a preliminary model for an improved, spiral-type tygon sock for ball-socket manipulators; a device or process for the remote loading of highly active samples into capsules for insertion into the beta-ray spectrometer; a feature in the gloved boxes whereby, during fuming processes, all the outlet air from the box must be sucked out from above the fuming substance; an arrangement referred to as a "bread board", which consists of a hot and a cold bath, a vacuum transfer bottle and a rotating reagent rack mounted on a board as one unit, for use in cave and box operations; an improved dissolver vessel for dissolving irradiated slugs, consisting of a platinum liner inserted in a fire brick, together with a heating element; a new stirrer for use in boxes; an improved wire extension for tongs for use in ball-socket manipulators; a six-volt spot light for use in the six-inch lead cave; and a vacuum safety valve for liquid flow control.

Twenty-seven Berkeley Boxes were assembled and fitted for radiochemical jobs during this period.

1174632

### Activity Handling Group

Decontamination is continuing in the new chamber, described in the January-March 1952 progress report. For a short period there was suspension of operations for improvement of the counting meter system in the chamber.

Approximately one quarter of the uranium scrap described in the last quarterly report has been converted to  $U_3O_8$ , a form suitable for shipment to a uranium recovery center. In view of the fact that this conversion process is proving to be an extremely taxing one equipment-wise, especially with regard to the filter system, consideration is being given to discontinue the operation and to transfer the remaining scrap to another installation.

Due to expansion of the synchrotron laboratory, the warehouse being used by the Health Chemistry group has been withdrawn and space in the basement of Bldg. 29 has been made available for Health Chemistry storage.

### Monitoring

Regular routine monitoring functions have remained essentially unchanged during this period. During shutdowns of all three accelerators in the Hill area, complete surveys for radioactive contamination were made of the accelerator buildings and areas; these areas were found to be clean.

A preliminary code system for evaluating operations and conditions on the project involving radioactive materials has been devised. Its purpose is to define hazard conditions and areas and regulate them so that research may be done safely and efficiently. Through its use a summary of existing conditions in a given area could be ascertained at a glance and judgement could be made with ease as to whether additional experiments could be introduced in that area, whether the present number has grown and should be reduced, etc.

Routine monitoring has been extended to Le Conte Physics Building, where processing of bombarded materials is now taking place to an increased extent.

In view of the ever increasing number of radioactive sources prepared and distributed by Health Chemistry on request, a system for maintaining the responsibility and safety of these sources has been set up, as they are being used by research personnel, such as physicists, the location of whose work is not in the routinely monitored areas. Fourteen of these specially prepared sources have been made during this quarter.

1174633

4254711

The group has made trial use with good results of a new gamma survey meter (a Jordan meter) whose range is 20 mr/hr to 500 r/hr, and an order has been placed for five of these instruments.

#### Airborne Activity Control Group

A continuous scrubber-aspirator-reservoir for active and acidic off-gases was devised, constructed, tested and installed. Initial results appear promising.

Component parts of gloved box manifolds have been redrawn to a modular basis for ease in fabrication and uniformity of ordering and installation.

A moisture- and oxygen-removal train for a specialized box was designed and fabricated. Performance tests are under way.

Methods were developed and applied for leak detecting, handling and restoring to use several dozen contaminated radium-beryllium sources belonging to the Health Physics group.

Consultations were held with the architects' office regarding design of Bldg. 161 (Radiation Laboratory building at Livermore) and other projects.

#### General

Preliminary plans and consultations have been made regarding UCRL Livermore project, with regard to laboratories, equipment and personnel.

Training of personnel from duPont in processing of radioactive materials as performed at Berkeley has been under way by the Health Chemistry and Chemistry groups.

1174634

Health Physics

B. J. Moyer

Statistical Summary of Monitoring Program

Survey Instruments Maintained

1. B-γ Ionization Chamber	43
2. Victoreen 263 Meters	19
3. I. D. L. Portable Survey Instruments	20
4. Cutie Pies	3
5. Recording γ-Intensity Meters	17
6. Victoreen Proteximeter	3
7. Fast Neutron Proportional Counters	6
8. Slow Neutron Proportion Counters	15
9. Balanced Chamber (Slow Neutron Survey Instrument)	2
10. Fast Neutron Proportional Counter (Portable)	2
11. Balanced Chamber (Fast Neutron Survey Instrument)	1
12. Special Tissue Wall Survey Instrument	1

Personnel Meters in Use

1. Total Personnel Covered with Film Badges	1,920
2. Total Man Days Coverage with Pocket Chamber	3,364
3. Total Man Days Coverage with Pocket Dosimeters	3,388
4. Total Man Days Coverage with Pocket Chambers (SNi)	2,920

Cases of Weekly Exposure above 0.3r

<u>Weekly Film Expos. above</u>	<u>184" Area</u>	<u>60" Area</u>	<u>Lin. Acc.</u>	<u>Chem.</u>	<u>Other</u>	<u>Total</u>
0.3	1	15	14	58	12	110
0.5	0	10	5	19	3	37
1.0	0	1	0	7	0	8
1.5	0	0	0	3	0	3
2.0	0	0	0	2	0	2
2.5	0	0	0	0	0	0

1174635

3509711

### Proportional Counters

The use of Araldite\* to make inert gas filled proportional counters has proved quite satisfactory. Both the cold setting and thermal setting types have been used to join the ends on dural cylindrical counters, and to cement foils to thin window counter frames. Bushings, taking the place of Kovar seals, et cetera, have been cast from the Type B Araldite, threaded, and with the cold setting Type 101 screwed into place. Any shape or form of bushing may be cast. With hardly any cleaning the bushings display a volume resistivity of  $10^{14}$  ohm's centimeters and a surface resistivity under high humidity conditions of approximately  $10^{14}$  ohm's per square.

Other gases could be used, in that Araldite is fairly inert chemically. However, it was observed that  $BF_3$  apparently causes polymerization of the Araldite, and eventual breakdown of the insulator. This action occurs within a week. Perhaps, with exceptionally dry gas and counter parts along with careful annealing of the bushing, Araldite could be used with  $BF_3$ .

Among the advantages of this method of counter construction are: little or no heat is required in making a leak-tight joint, construction is simplified and dural can be used without welding and the accompanying cleaning problems.

---

\* Trade name of the ethoxyline resins obtainable from Ciba Company Inc., New York.

1174636